

TravelMate 505

Service Guide

Service guide files and updates are available on the AIPG/CSD web; for more information, please refer to <http://csd.acer.com.tw>

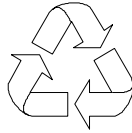

100% Recycled Paper

PART NO.: 49.43F02.001
DOC. NO.: C4225-R01

PRINTED IN TAIWAN

Copyright

Copyright © 1999 by Acer Incorporated. All rights reserved. No part of this publication may be reproduced, transmitted, transcribed, stored in a retrieval system, or translated into any language or computer language, in any form or by any means, electronic, mechanical, magnetic, optical, chemical, manual or otherwise, without the prior written permission of Acer Incorporated.

Disclaimer

The information in this guide is subject to change without notice.

Acer Incorporated makes no representations or warranties, either expressed or implied, with respect to the contents hereof and specifically disclaims any warranties of merchantability or fitness for any particular purpose. Any Acer Incorporated software described in this manual is sold or licensed "as is". Should the programs prove defective following their purchase, the buyer (and not Acer Incorporated, its distributor, or its dealer) assumes the entire cost of all necessary servicing, repair, and any incidental or consequential damages resulting from any defect in the software.

Acer is a registered trademark of Acer Corporation.

Intel is a registered trademark of Intel Corporation.

Pentium and Pentium II/III are trademarks of Intel Corporation.

Other brand and product names are trademarks and/or registered trademarks of their respective holders.

Conventions

The following conventions are used in this manual:

Screen messages	Denotes actual messages that appear on screen.
NOTE	Gives bits and pieces of additional information related to the current topic.
WARNING	Alerts you to any damage that might result from doing or not doing specific actions.
CAUTION	Gives precautionary measures to avoid possible hardware or software problems.
IMPORTANT	Reminds you to do specific actions relevant to the accomplishment of procedures.

Preface

Before using this information and the product it supports, please read the following general information.

1. This Service Guide provides you with all technical information relating to the BASIC CONFIGURATION decided for Acer's "global" product offering. To better fit local market requirements and enhance product competitiveness, your regional office MAY have decided to extend the functionality of a machine (e.g. add-on card, modem, or extra memory capability). These LOCALIZED FEATURES will NOT be covered in this generic service guide. In such cases, please contact your regional offices or the responsible personnel/channel to provide you with further technical details.
2. Please note WHEN ORDERING FRU PARTS, that you should check the most up-to-date information available on your regional web or channel. If, for whatever reason, a part number change is made, it will not be noted in the printed Service Guide. For ACER-AUTHORIZED SERVICE PROVIDERS, your Acer office may have a DIFFERENT part number code to those given in the FRU list of this printed Service Guide. You MUST use the list provided by your regional Acer office to order FRU parts for repair and service of customer machines.

Chapter 1	System Specifications	1
Features	1
Keyboard	3
Keyboard Ergonomics	6
Touchpad	6
System Block Diagram	8
Board Layout	9
Top View	9
Bottom View	10
Panels	11
Front Panel	11
Rear Panel	12
Right Panel	13
Indicators	14
Hardware Specifications and Configurations	15
Chapter 2	System Utilities	27
BIOS Setup Utility	27
System Information	28
Basic System Configuration	30
Startup Configuration	31
Onboard Device Configuration	32
System Security	33
Load Default Settings	35
AFlash Utility	36
Executing AFlash	36
System Utility Diskette	37
Panel ID Utility	37
Thermal and Fan Utility	37
Main Board Data Utility	37
System Diagnostic Diskette	38
Running PQA Diagnostics Program	38
Chapter 3	Machine Disassembly and Replacement	41
General Information	42
Before You Begin	42
Connector Types	42
Disassembly Procedure Flowchart	43
Removing the Battery Pack	45
Removing the DIMM	45
Removing the Modem Board	45
Removing the Keyboard	46
Removing the LCD Module	47
Disassembling the LCD	48
Disassembling the Main Unit	50
Removing the Heatsink and CPU EMI Shield	50
Removing the Hard Disk Drive	50
Removing Upper Case	51
Removing the Floppy Disk Drive/CD-ROM Drive Combo Module	51
Removing the Speakers	52
Removing the Audio I/O and Battery Connection Board	53
Removing the Fan	53
Removing the Mainboard	53

Table of Contents

Removing the PCMCIA Card	54
Removing the Touchpad Module	54
Disassembling the Hard Disk Drive Module	55
Disassembling the Floppy Disk Drive and CD-ROM Combo Module	56
Chapter 4 Troubleshooting	57
System Check Procedures	58
Diskette Drive Check	58
CD-ROM Drive Check	58
Keyboard or Auxiliary Input Device Check	58
Memory Check	59
Power System Check	59
Touchpad Check	60
Index of Error Message	61
Index of Symptom-to-FRU Error Message	64
Intermittent Problems	68
Undetermined Problems	69
Index of PQA Diagnostic Error Code, Message	70
Chapter 5 Jumper and Connector Locations	71
Top View	71
Bottom View	72
Chapter 6 FRU (Field Replaceable Unit) List	73
Appendix A Model Definition and Configuration	87
Appendix B Test Compatible Components	89
Microsoft Windows 98 ACPI Environment Test	90
Appendix C Online Support Information	93
Index	95

System Specifications

Features

This computer was designed with the user in mind. Here are just a few of its many features:

Performance

- Intel® Celeron™ processor with 128 KB level 2 cache
- 64-bit/128-bit main memory
- Large LCD display and PCI video with 128-bit graphics acceleration
- Internal CD-ROM drive
- Built-in FDD module
- High-capacity, Enhanced-IDE hard disk
- NiMH battery pack
- Power management system with hibernation power saving modes

Multimedia

- 16-bit high-fidelity stereo audio with 3D sound and wavetable synthesizer
- Built-in dual speakers
- Ultra-slim, high-speed CD-ROM drive

Connectivity

- High-speed fax/data modem port
- USB (Universal Serial Bus) port

Human-centric Design and Ergonomics

- All-in-one design (CD-ROM, FDD, HDD)
- Sleek, smooth and stylish design
- Full-sized keyboard
- Wide and curved palm rest
- Ergonomically-centered touchpad pointing device

Expansion

- CardBus PC card (formerly PCMCIA) slots (two type II/I or one type III), with ZV (Zoomed Video) port support
- Upgradeable memory and hard disk

Display

The large graphics display offers excellent viewing, display quality and desktop performance graphics. The computer supports two different display configurations — High Performance Addressing (HPA) or Thin-Film Transistor (TFT).

Video Performance

PCI video with 128-bit graphics acceleration and 2 MB video memory boost video performance.

Simultaneous Display

The computer's large display and multimedia capabilities are great for giving presentations. If you prefer, you can also connect an external monitor when giving presentations. This computer supports simultaneous LCD and CRT display. Simultaneous display allows you to control the presentation from your computer and at the same time face your audience. You can also connect other output display devices such as LCD projection panels for large-audience presentations.

Power Management

The power management system incorporates an “automatic LCD dim” feature that automatically dims the LCD when the computer is powered by a battery pack to conserve battery power. See “Power Management” for more information on power management features.

Opening and Closing the Display

To open the display, slide the display cover latch to the left and lift up the cover. Then tilt it to a comfortable viewing position. The computer employs a microswitch that turns off the display (and enters standby mode) to conserve power when you close the display cover and turns it back on when you open the display cover.

NOTE: If an external monitor is connected, the computer turns off the display (but does not enter standby mode) when you close the display cover.

To close the display cover, fold it down gently until the display cover latch clicks into place.

CAUTION: To avoid damaging the display, do not slam it when you close it. Also, do not place any object on top of the computer when the display is closed.

Keyboard

The keyboard has full-sized keys and an embedded keypad, separate cursor keys, two Windows keys and twelve function keys.

Special Keys

Lock Keys

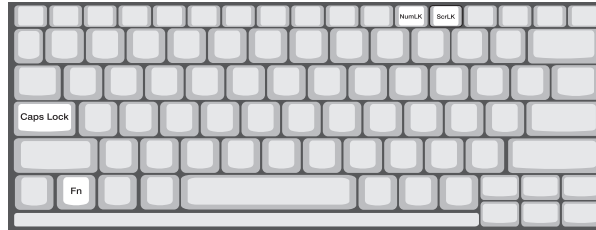

The keyboard has three lock keys which you can toggle on and off.

Lock Key	Description
Caps Lock	When Caps Lock is on, all alphabetic characters typed are in uppercase.
Num Lock (Fn-F11)	When Num Lock is on, the embedded keypad is in numeric mode. The keys function as a calculator (complete with the arithmetic operators +, -, *, and /). Use this mode when you need to do a lot of numeric data entry. A better solution would be to connect an external keypad.
Scroll Lock (Fn-F12)	When Scroll Lock is on, the screen moves one line up or down when you press ↑ or ↓ respectively. Scroll Lock does not work with some applications.

Embedded Numeric Keypad



The embedded numeric keypad functions like a desktop numeric keypad. It is indicated by small characters located on the upper right corner of the keycaps. To simplify the keyboard legend, cursor-control key symbols are not printed on the keys.

Desired Access	Num Lock On	Num Lock Off
Number keys on embedded keypad	Type numbers in a normal manner.	
Cursor-control keys on embedded keypad	Hold Shift while using cursor-control keys.	Hold Fn while using cursor-control keys.
Main keyboard keys	Hold Fn while typing letters on embedded keypad.	Type the letters in a normal manner.

NOTE: If an external keyboard or keypad is connected to the computer, the NumLock feature automatically shifts from the internal keyboard to the external keyboard or keypad.

Windows Keys

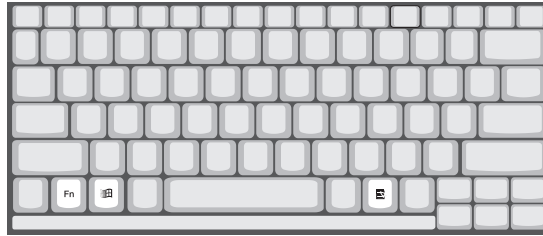

The keyboard has two keys that perform Windows-specific functions.

Key	Description
Windows logo key	Start button. Combinations with this key perform special functions. Below are a few examples: ⊞ + Tab (Activates next Taskbar button) ⊞ + E (Explores My Computer) ⊞ + F (Finds Document) ⊞ + M (Minimizes All) Shift + ⊞ + M (Undo Minimize All) ⊞ + R (Displays the Run dialog box)
Application key (Fn-Application key)	Opens the application's context menu (same as right-click).

The Euro Symbol



If your keyboard is in any of the following languages -- United States-International, United Kingdom, French, German, Italian, Spanish, Portuguese, Danish, Swiss German, Swiss French, Czech, Belgian, Norwegian, Hungarian, Turkish, Swedish or Finnish -- you can type the Euro symbol on your keyboard.

IMPORTANT:(for US keyboard users): The keyboard type is set when you first set up Windows. For the Euro symbol to work, the keyboard type has to be set to United States-International.

To verify the keyboard type:

1. Click on **Start, Settings, Control Panel**.
2. Double-click on **Keyboard**.
3. Click on the **Language** tab.
4. Verify that the keyboard type used for "English (United States)" is set to **United States-International**.
5. If not, select and click on **Properties**; then select **United States-International** and click on **OK**.
6. Click on **OK**.

To type the Euro symbol:

1. Locate the Euro symbol on your keyboard.
2. Open a text editor or word processor.
3. Hold **Alt Gr** and press the Euro symbol.

NOTE: The **Alt Gr** is only used together with the Euro symbol. Some fonts and software do not support the Euro symbol. Please refer to <http://www.microsoft.com/typography/faq/faq12.htm> for more information.

Hot Keys



The computer employs hot keys or key combinations to access most of the computer's controls like screen contrast and brightness, volume output and the BIOS setup utility

Hot Key	Icon	Function	Description
Fn-F1	?	Hotkey help	Displays a list of the hotkeys and their functions.
Fn-F2	⚙️	Setup	Accesses the notebook configuration utility.
Fn-F3	🔋	Power Scheme Toggle	Switch between the different Power Management schemes.
Fn-F4	Z ^Z	Sleep	Puts the computer in Sleep mode, which can be defined via the advanced section of the Power Management Properties in the Windows Control Panel.
Fn-F5	🖥️	Display toggle	Switches display output between the display screen, external monitor (if connected) and both the display screen and external monitor.
Fn-F6	🌟	Screen blank	Turns the display screen backlight off to save power. Press any key to return.
Fn-F7	🖱️	Touchpad on/off	Turns the internal touchpad on and off. When you connect an external PS/2 mouse, the computer automatically disables the touchpad.
Fn-F8	🔊	Speaker on/off	Turns the speakers on and off; mutes the sound.
Fn-↑	🕒	Contrast up	Increases the screen contrast (available only for models with HPA displays).
Fn-↓	🕒	Contrast down	Decreases the screen contrast (available only for models with HPA displays).
Fn-→	☀️	Brightness up	Increases the screen brightness.
Fn-←	☀️	Brightness down	Decreases the screen brightness.

Activating Hotkeys

When activating hotkeys, press and hold the first key Fn before pressing the other key in the hotkey combination.

Keyboard Ergonomics

Located below the keyboard, the wide and curved palm rest is ergonomically designed to provide you with a very comfortable place to rest your hands while you type.

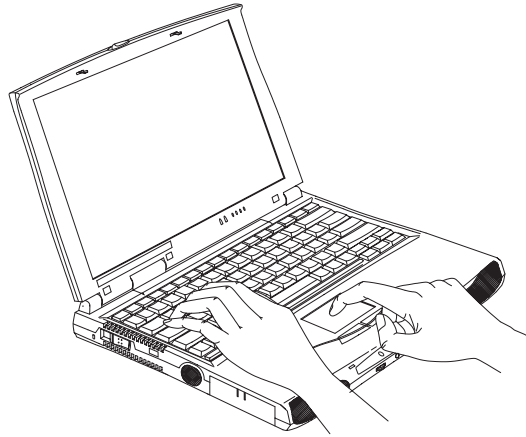

Touchpad

The built-in touchpad is a PS/2-compatible pointing device that senses movement on its surface. This means that the cursor responds as you move your finger on the surface of the touchpad. The central location on the palm rest provides optimum comfort and support.

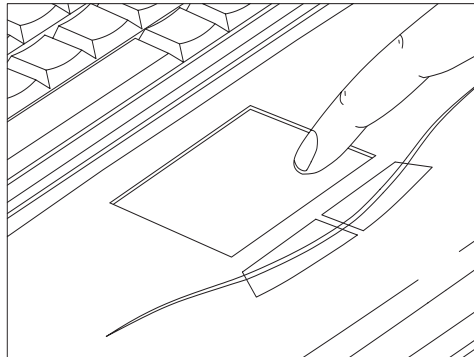

NOTE: When you connect an external PS/2 mouse, the computer automatically disables the internal touchpad.

Touchpad Basics

The following items teach you how to use the touchpad:

1. Move your finger across the touchpad to move the cursor.
2. Press the left and right buttons located on the edge of the touchpad to do selection and execution functions. These two buttons are similar to the left and right buttons on a mouse. Tapping on the touchpad produces similar results.

Function	Left Button	Right Button	Tap
Execute	Click twice quickly		Tap twice (at the same speed as double-clicking the mouse button).
Select	Click once		Tap once
Drag	Click and hold, then use finger to drag the cursor on the touchpad.		Tap twice (at the same speed as double-clicking the mouse button) and hold finger to the touchpad on the second tap to drag the cursor.
Access context menu		Click once	

NOTE: Keep your fingers dry and clean when using the touchpad. Also keep the touchpad dry and clean. The touchpad is sensitive to finger movements. Hence, the lighter the touch, the better the response. Tapping too hard will not increase the touchpad's responsiveness.

System Block Diagram

TM505 BLOCK DIAGRAM

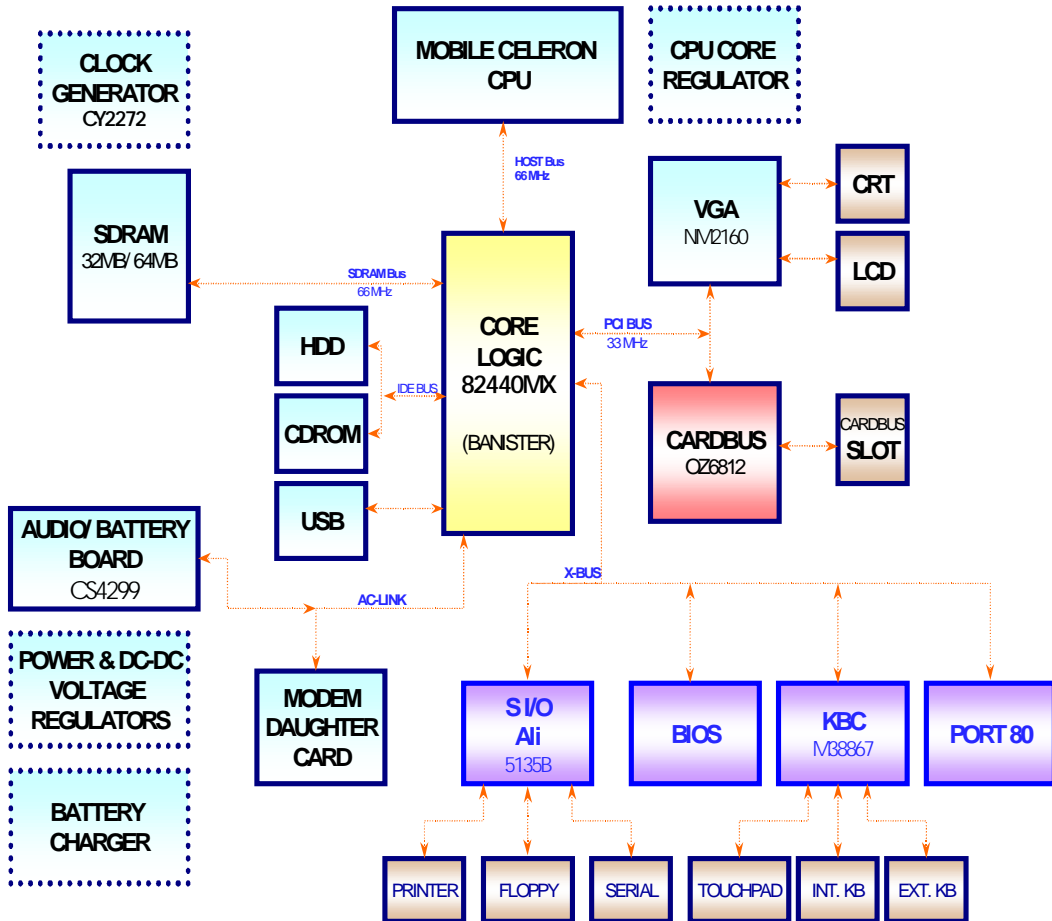

Board Layout

Top View

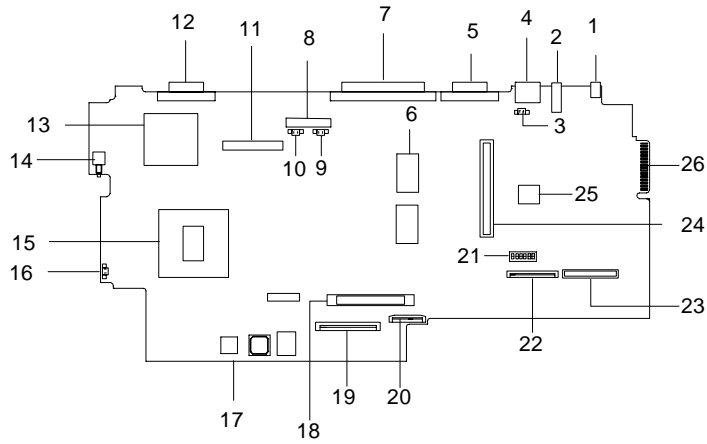

1	AC Adapter Connector	14	Power Push Switch
2	USB Port	15	Celeron Processor
3	LCD Corner Switch Connector	16	Fan Connector
4	PS/2 Port	17	Onboard DC/DC Charger
5	Serial Port	18	HDD Connector
6	Onboard System Memory	19	Internal Keyboard Connector
7	Parallel Port	20	Touch Pad Connector
8	LED Board Connector	21	Onboard Switch
9	RTC Battery Connector	22	Diskette Drive Connector
10	Fan Connector	23	CD-ROM Connector
11	LCD Connector	24	PCMCIA Slot
12	VGA Port	25	Keyboard Controller
13	VGA Controller	26	Golden Finger for Debug

Bottom View

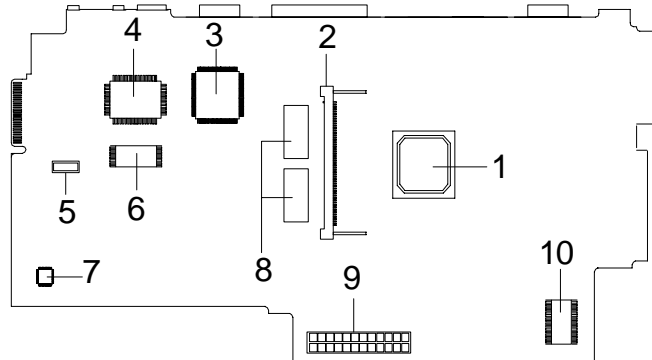

- | | | | |
|---|------------------------|----|-------------------------|
| 1 | Intel FW 82443 Chipset | 6 | BIOS Flash ROM |
| 2 | DIMM Socket | 7 | Audio CODEC |
| 3 | CardBus Controller | 8 | Onboard System Memory |
| 4 | Super I/O Controller | 9 | Audio/Battery Connector |
| 5 | Modem Board Connector | 10 | Clock Generator |

Panels



Ports allow you to connect peripheral devices to your computer as you would with a desktop PC.

NOTE: See chapter 3 on how to connect external devices to the computer.

Front Panel

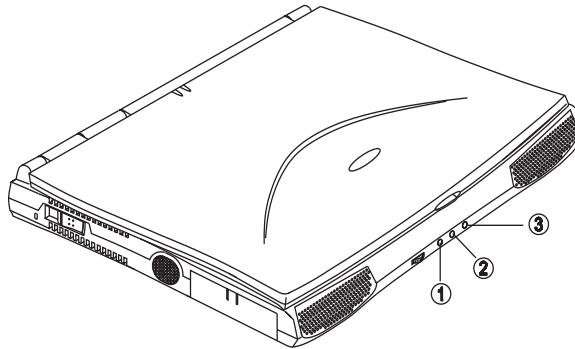
The front panel contains ports for external audio connections.



#	Icon	Port	Connects to...
1		Speaker-out jack	Speakers or headphones
2		Audio line-in jack	Audio line-in device with a 3.5mm minijack (e.g., audio CD player, stereo walkman)
3		Microphone-in jack	3.5mm minijack condenser microphone

Rear Panel

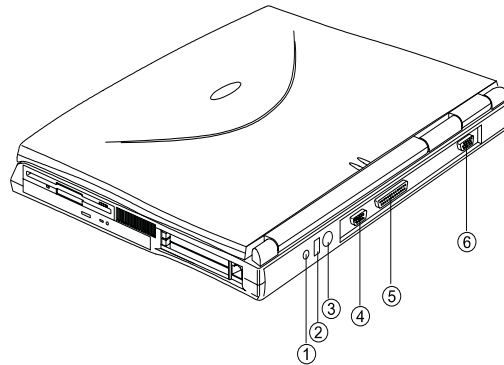

#	Icon	Port	Connects to...
1		DC-in jack	AC adapter and power outlet
2		USB port	USB devices (e.g., USB mouse)
3		PS/2 port	PS/2-compatible devices (e.g., PS/2 keyboard/mouse/keypad)
4		Serial port	Serial devices (e.g., serial mouse)
5		Parallel port	Parallel devices (e.g., parallel printer)
6		External monitor port	Display monitor (up to 1024x768 resolution, 64K-colors)

Universal Serial Bus

The Universal Serial Bus (USB) port is a high-speed serial bus which allows you to connect and daisy-chain USB peripherals without taking up precious system resources.

Right Panel

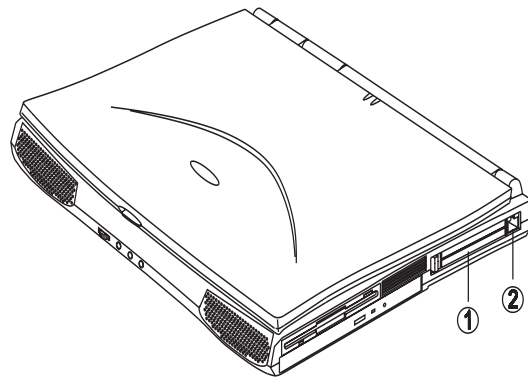





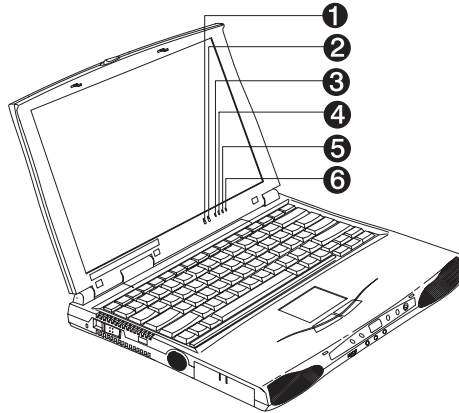

#	Icon	Port	Connects to...
1		PC Card slot	16-bit PC Cards and 32-bit CardBus PC Cards (ZV support)
2		Modem jack	Phone line (only for models with an internal fax modem)

Indicators

The computer has six easy-to-read status indicators (LEDs) under the display screen.



The Power and Standby indicators are visible even when you close the display cover so you can see the status of the computer while the cover is closed.

#	Icon	Function	Description
1		Power	Lights when the computer is on. Blinks when a battery-low condition occurs.
2		Standby	Lights when the computer enters Standby mode.
3		Media Activity	Lights when the floppy drive, hard disk or CD-ROM drive or DVD-ROM drive is active.
4		Battery Charge	Lights when the battery is being charged.
5		Caps Lock	Lights when Caps Lock is activated.
6		Num Lock (Fn-F11)	Lights when Numeric Lock is activated.

Hardware Specifications and Configurations

System Board Major Chips

Item	Controller
System Core Logic	Intel 82440 MX (Banister)
Super I/O Controller	ALI 5135B
Keyboard Controller	Mitsubishi M38867 V JG TQ FP
Audio Controller	Intel 82440 MX (Banister)
PCMCIA Controller	O2 OZ6812
VGA Controller	NeoMagic NM2160

Processor

Item	Specification		
CPU Type	Intel Mobile Celeron-400 MHz Processor	Intel Mobile Celeron-433 MHz Processor	Intel Mobile Celeron-466 MHz Processor
CPU Specification	1. Integrated primary L1 instruction and data cache 2. 128-Kbyte L2 cache integrated onto the processor die 3. Low power GTL+ system bus interface		
CPU Package	BGA package	BGA package	BGA package
CPU Core Voltage	1.6 V	1.9 V	1.9 V
CPU I/O Voltage	2.5 V	2.5 V	2.5 V

BIOS

Item	Specification
BIOS vendor	Acer
BIOS Version	V3.0
BIOS ROM type	Flash ROM
BIOS ROM size	256KB
BIOS package	32-pin TSOP
Supports protocol	PCI 2.1, SMI & APM 1.2, DMI 2.00.1, E-IDE, ACPI, USB, ESCD 1.03, ANSI ATA 3.0, PnP 1.0a, Bootable CD-ROM 1.0, ATAPI, ECP/EPP 1.7 & 1.9
BIOS password control	Set by switch, see SW4 settings

Second-Level Cache

Item	Specification
Cache controller	Intel 82440 MX (Banister)
Cache size	128 KB (Celeron CPU type)
1st level cache control	Always enabled
2nd level cache control	Always enabled
Cache scheme control	Fixed in write-back

System Memory

Item	Specification
Memory controller	Intel Banister 82440 MX
Onboard memory size	32/64 MB
DIMM socket	1
Supported memory size per socket	32/64/128 MB
Supported maximum memory size	192 MB (64 MB + 128 MB)
Supported DIMM type	Synchronous DRAM
Supported DIMM speed	66 MHz
Supported DIMM voltage	3.3V
Supported DIMM package	144-pin so-DIMM

Memory Combinations

On Board	Slot 1	Total Memory
32 MB	0 MB	32 MB
32 MB	32 MB	64 MB
32 MB	64 MB	96 MB
32 MB	128 MB	160 MB
64 MB	0 MB	64 MB
64 MB	32 MB	96 MB
64 MB	64 MB	128 MB
64 MB	128 MB	192 MB

LAN Interface

Item	Specification
LAN Controller	None
LAN Controller Resident Bus	None
LAN Port	None
Function Control	None

MODEM Interface

Item	Specification
Chipset	Lucent 1646
Fax modem data baud rate (bps)	14.4 K
Data modem data baud rate (bps)	56 K
Supported modem protocol	V.90 data modem, V.17 fax modem, and digital line protection operation
Modem connector type	RJ45 (Capable of RJ11)
Modem connector location	Right side

Floppy Disk Drive Interface

Item	Specification		
Vendor & model name	Mitsumi D353F3X		
Floppy Disk Specifications			
Media recognition	2DD (720KB)	2HD (1.2MB, 3-mode)	2HD (1.44MB)
Sectors/track	9	15	18
Tracks	80	80	80
Data transfer rate (Kbit/s)	1 MB	1.6 MB	2 MB
Rotational speed (RPM)	300	360	300
Read/write heads	2		
Encoding method	MFM/FM		
Power Requirement			
Input Voltage (V)	+5V ±10%		

Hard Disk Drive Interface

Item	Specification	
Vendor & Model Name	IBM DARA 206000	IBM DARA 209000
Drive Format		
Capacity (MB)	6000	9000
Bytes Per Sector	512	512
Logical Heads	15	16
Logical Sectors	63	63
Drive Format		
Logical Cylinders	12416	16383
Physical Read/Write Heads	2	3
Disks	1	2
Spindle Speed (RPM)	4200	4200
Performance Specifications		
Buffer Size	418 KB	418 KB
Interface	IDE	IDE
Data Transfer Rate (Disk-Buffer, Mbits/s)	161.6 - 85.5	161.6 - 85.5
Data Transfer Rate (Host-Buffer, Mbytes/s)	66.6 max 16.6 max	
DC Power Requirements		
Voltage Tolerance	5V +/- 5%	5V +/- 5%

CD-ROM Interface

Item	Specification
Vendor & Model Name	TEAC CD-224E-A26 24X
Performance Specification	
Transfer rate (KB/sec)	1545KB/sec ~ 3,600KB/sec (FULL - CAV)
Access time (typ.)	130 msec. (typ.)
Rotation speed	5136 rpm (typ.)
Memory Buffer	None

CD-ROM Interface

Item	Specification
Data Buffer	128 KB
Interface	ATAPI
Applicable disc format	CD-DA, CD-ROM (Mode-1, Mode-2), CD-ROM XA MODE-2 (FORM-1, FORM-2), Multi-Session Photo CD, CD-I, Video CD, Enhanced CD & CD PLUS Compatible
Loading mechanism	Drawer with soft eject and emergency eject hole
Power Requirement	
Input Voltage	5V +/- 5%

Audio Interface

Item	Specification
Audio Controller	Intel 82440 MX (Banister)/Cirrus Logic CS4229
Audio onboard or optional	Built-in
Mono or Stereo	Stereo
Resolution	20 bit stereo Digital to Analog converter 18 bit stereo Analog to Digital converter
Compatibility	PC '98, PC '99, AC97 2.1
Mixed sound source	Line-in, CD, Video, AUX
Voice channel	8-/16-bit, mono/stereo
Sampling rate	44.1 KHz
Internal microphone	None
Internal speaker/quantity	Yes/2 pieces, on two sides of front panel
Supported PnP DMA channel	DMA channel 0 DMA channel 1
Supported PnP IRQ	IRQ11

Video Interface

Item	Specification
Chip vendor	NeoMagic
Chip name	NM2160
Chip voltage	3.3 volts
Supports ZV (Zoomed Video) port	Yes
Graph interface	PCI bus
Maximum resolution (LCD)	800 x 600 (True color/24 bit)
Maximum resolution (CRT)	1024 x 768 (High color/16bit)

Video Memory

Item	Specification
Fixed	Fixed, built-in NM2160 video controller
Video memory size	2.0 MB

Video Resolution Modes

Resolution	Refresh Rate	
	CRT Only	LCD/CRT Simultaneous
640x480x256	75	60
640x480x64K	75	60
640x480x16M	75	60
800x600x256	75	60
800x600x64K	75	60
800x600x16M	75	60
1024x768x256	75	60
1024x768x64K	75	60
1024x768x16M	75	60

Parallel Port

Item	Specification
Parallel port controller	ALI 5135B
Number of parallel port	1
Location	Rear side
Connector type	25-pin D-type connector, in female type
Parallel port function control	Enable/Disable by BIOS Setup
Supports ECP	Yes (set by BIOS setup)
Optional ECP DMA channel (in BIOS Setup)	DMA channel 1 DMA channel 3
Optional parallel port I/O address (in BIOS Setup)	3BCh, 378h, 278h
Optional parallel port IRQ (in BIOS Setup)	IRQ7

Serial Port

Item	Specification
Serial port controller	ALI 5135B
Number of serial port	1
Supports 16550 UART	Yes
Connector type	9-pin D-type connector, in male type
Location	Rear side
Serial port function control	Enable/disable by BIOS Setup
Optional serial port (in BIOS Setup)	3F8h, 2F8h, 3E8h, 2E8h,
Optional serial port IRQ (in BIOS Setup)	IRQ4, IRQ3

USB Port

Item	Specification
HCI	UHCI 1.0
Number of USB Port	1
Location	Rear Side
Serial Port Function Control	Enable / Disable by BIOS Stup

IrDA Port

Item	Specification
Vendor & Model Name	None
Input Power Supply Voltage	None
Transfer Data Rate	None
Transfer Distance	None
Compatible Standard	None
Output Radiant Intensity Half Angle	None
Number of IrDA Port	None
16550 UART Support	None
FIR Location	None
Selection Serial Port (by BIOS Setup)	None

PCMCIA Port

Item	Specification
PCMCIA controller	O2 OZ6912
Supported card type	Type-II/ Type-III
Number of slots	One type-II or one type-III
Access location	Right side
Supported ZV (Zoomed Video) port	Yes
Supported 32 bit CardBus	Yes (IRQ9)

Keyboard

Item	Specification
Keyboard controller	Mitsubishi M38867 VJG TQFP
Keyboard vendor & model name	API
Total number of keypads	84-/85-/88-key
Windows 95 keys	Yes
Internal & external keyboard work simultaneously	Yes

Battery

Item	Specification
Vendor & model name	Panasonic BTP-1831
Battery Type	NiMH
Pack capacity	3500 mAh
Cell voltage	1.2V
Number of battery cell	8
Package configuration	8S
Package voltage	9.6V

DC-DC/Charger Converter

Item	Specification
Vendor & Model Name	Acer
Input voltage	AC adapter: 19V-21V Battery: 12V-16.8V
DC/DC converter output	
Output Rating	5V 3.3V 12V 5V SB
Current (w/load, A)	0~2 0~3.5 0~0.25 0.02
Charger output	
Normal charge (charge while system is not operative)	2.2A
Background charge (charge even system is still operative)	0.8A
Battery-low 2 level (V)	8.8V
Battery-low 3 level (V)	8V
Protection	
Charger protection	Security timer control Over temperature protection Over voltage protection
DC/DC converter protection	OVP (Over Voltage Protection, V) OCP (Over Current Protection, A)

DC-AC LCD Inverter

Item	Specification		
Vendor & Model Name	Ambit T62.121.C.00 (12.1")		
Input Voltage (V)	7.3 (min.)	None	22 (max.)
Input Current (mA)	None	None	1000 (max.)
Output Voltage (Vrms, no load)	1100 (min.)	None	1400 (max.)
Output Voltage Frequency (KHz)	40 (min.)	None	65 (max.)

Item	Specification			
Output Current (mArms)	Min.	Typ.	Max.	Remark
Output Current (mArms)	6.3	7.0	7.7	Vadj : 3.2 V
Output Current (mArms)	0.7	1.0	1.3	Vadj : 2.15 V

NOTE: DC-AC inverter is used to generate very high AC voltage, to support LCD CCFT backlight user, and it is also responsible for the control of LCD brightness. Avoid touching the DC-AC inverter area while the system unit is turned on.

NOTE: There is an EEPROM in the inverter, which stores its supported LCD type and ID code. If you replace a new inverter or replace the LCD with one of a different brand, use Inverter ID utility to update the ID information.

LCD

Item	Specification	
Vendor & model name	12.1" Sharp LM121SS1T53	12.1" Hitachi TX31D27VCICBB
Mechanical Specifications		
LCD display area (diagonal, inch)	12.1	12.1
Display technology	DSTN	TFT
Resolution	SVGA (800x600)	SVGA (800x600)
Supports colors	16 M	16 M
Optical Specifications		
Brightness control	Keyboard hotkey	Keyboard hotkey
Contrast control	Keyboard hotkey	None
Electrical Specifications		
Supply voltage for LCD display (V)	3.3 (typ.)	3.3 (typ.)
Supply voltage for LCD backlight (Vrms)	650 (typ)	650 (typ)

AC Adapter

Item	Specification
Vendor & Model Name	Delta ADP-60XBVD
Input Requirements	
Maximum Input Current (A, @90Vac, full load)	1A @ 90 Vac
Nominal Frequency (Hz)	47 - 63
Frequency Variation Range (Hz)	47 - 63
Nominal Voltages (Vrms)	90 - 270
Inrush Current	The maximum inrush current will be less than 50A and 100A when the adapter is connected to 115Vac(60Hz) and 230Vac(50Hz) respectively.
Efficiency	It should provide an efficiency of 83% minimum, when measured at maximum load under 115V(60Hz).
Output Ratings (CV mode)	
DC Output Voltage	+19.0V - 20.5V
Noise + Ripple	300mvp-pmax (20MHz bandwidth)
Load	0A (min.) 2.4A (max.)
Output Ratings (CC mode)	
DC Output Voltage	20V +/- 1.0V
Constant Output	3.6 +/- 0.3A
Dynamic Output Characteristics	
Turn-on Delay Time	2 sec. (@115Vac)
Hold Up Time	8 ms min. (@115Vac input, full load)
Over Voltage Protection (OVP)	24 V
Short Circuit Protection	Output can be shorted without damage
Electrostatic Discharge (ESD)	15kV (at air discharge) 8kV (at contact discharge)
Dielectric Withstand Voltage	
Primary to Secondary	1500Vac (or 2121 Vdc) for 1 second
Leakage Current	0.25 mA max. (@ 254 Vac, 60Hz)
Regulatory Requirements	Internal filter meets: 1. FCC class B requirements (USA) 2. VDE 243/1991 class B requirements (German) 3. CISPR 22 Class B requirements (Scandinavia) 4. VCCI class II requirements (Japan)

Power Management

Power Saving Mode	Phenomenon
<p>Standby Mode</p> <p>Waiting time specified by the System Standby value or the operating system elapses without any system activity.</p> <p>Or</p> <p>When the computer is about to enter Hibernation mode (e.g., during a battery-low condition), but the Hibernation file is invalid or not present.</p>	<input type="checkbox"/> The buzzer beeps <input type="checkbox"/> The Standby indicator lights up
<p>Hibernation Mode</p> <p>When customized functions for power management are set to Hibernation and the corresponding action is taken.</p>	<input type="checkbox"/> All power shuts off
<p>Display Standby Mode</p> <p>Keyboard, built-in touchpad, and an external PS/2 pointing device are idle for a specified period.</p>	<input type="checkbox"/> The display shuts off
<p>Hard Disk Standby Mode</p> <p>Hard disk is idle within a specified period of time.</p>	<input type="checkbox"/> Hard disk drive is in standby mode. (spindle turned-off)

Environmental Requirements

Item	Specification
Temperature	
Operating	+5 ~ +35 Degree C
Non-Operating	-20 ~ + 60 Degree C
Humidity	
Operating	20% ~ 80% RH, Non-condensing
Non-Operating	20% ~ 90% RH, Non-condensing
Vibration	
Operating (Unpacked)	5 ~ 25.6 Hz, 0.38 mm
Non-Operating	
Unpacked	5 ~ 27.1 Hz, 0.6G
	27.1 ~ 50 Hz, 0.41 mm
	50 ~ 500 Hz, 2G
Packed	5 ~ 62.6 Hz, 0.51 mm
	62.6 ~ 500 Hz, 4 G

Mechanical Specifications

Item	Specification
Dimensions	308mm x 257mm x 44.7mm
Weight	7lbs (Battery included)
I/O Ports	Mouse, 1 Parallel, 1 Serial, 1 USB, 1 Modem Jack, 1 PCMCIA Slot, 1 VGA Port, 1 Microphone Jack, 1 Line-in Jack, 1 Line-out Jack
Drive Bays	One 3.5" FDD, One CD-ROM
Material	Plastic
Indications	Power Light, Sleep Mode Light, Media Activity Light, Battery Charge Light, Caps Lock Light, Numbers Lock Light
Switch	Power

Memory Address Map

Memory Address	Size	Function
00000000-0009FFFF	640 KB	Base memory
000A0000-000BFFFF	128 KB	Video memory
000C0000-000CBFFF	40 KB	Video BIOS
000E0000-000FFFFF	128 KB	System BIOS
00100000-top limited	--	Extended (DIMM) memory
04000000-04000FFF	4 KB	PCMCIA controller (slot 1)
04001000-04001FFF	4 KB	PCMCIA controller (slot 2)
80100000-801000FF	256 B	Lucent Win Modem
80500000-805FFFFF	1 MB	NetMagic VGA
80800000-80BFFFFF	3 MB	Neomagic VGA
81000000-81FFFFFF	16 MB	
82100000-82100FFF	4 MB	
FFFF0000-FFFFFFFF	64 KB	System board extension for PnP BIOS

I/O Address Map

I/O Address	Function
000-00F	DMA controller-1
020-021	Interrupt controller-1
040-043	Timer 1
060, 064	Keyboard controller 8742 chip select
061	System speaker out
040B	DMA controller-1
061	System speaker
070-071	Real-time clock and NMI mask
080-08F	DMA page register
0A0-0A1	Interrupt controller-2
0C0-0DF	DMA controller-2
0F0-0FF	Numeric data processor
120-13F, 180-18F	Power management controller
170-177	2nd EIDE device (CD-ROM) select
1F0-1F7	1st EIDE device (hard drive) select
220-22F	Audio
240-24F	Audio(optional)
278-27F	Parallel port 3
2E8-2EF	LT Win modem or COM4 (optional)
2F8-2FF	COM2 or LT Win modem(optional)
378, 37A	Parallel port 2
3BC-3BE	Parallel port 1
3B0-3BB, 3C0-3DF	Video Controller
3F0h-3F7	Standard Floppy Disk Controller
3E8-3EF	COM3 or LT Win modem (optional)
3F0-3F7	Floppy disk controller
3F8-3FF	COM1 or LT Win modem (optional)
480-48F, 4D6	DMA controller-1
4D0-4D1, CF8-CFF	PCI configuration register

IRQ Assignment Map

Interrupt Channel	Function
NMI	System errors
IRQ0	System timer
IRQ1	Keyboard
IRQ2	Cascade
IRQ3	COM2
IRQ4	COM1
IRQ5	VGA
IRQ6	Floppy
IRQ7	LPT1
IRQ8	Real time clock
IRQ9	PCMCIA (Optional)
IRQ10	USB
IRQ11	Audio/Modem/CardBus
IRQ12	PS2 pointing device
IRQ13	Numeric data processor
IRQ14	1st IDE device (hard disk) 2nd EIDE device (CD-ROM drive)
IRQ15	Optional

DMA Channel Assignment

DMA Channel	Function
DRQ0	Audio (optional)
DRQ1	ECP or Audio (optional)
DRQ2	Floppy
DRQ3	ECP (optional)
DRQ4	DMA controller
DRQ5	Not used
DRQ6	Not used
DRQ7	Not used

System Utilities

BIOS Setup Utility

The BIOS Setup Utility is a hardware configuration program built into your computer's BIOS (Basic Input/Output System).

Your computer is already configured and optimized properly, and you do not need to run this utility. However, if you encounter configuration problems, you may need to run it.

To activate the BIOS Setup Utility, press **F2** during POST while the TravelMate logo is being displayed.

Navigating the BIOS Setup Utility

There are six menu options: System Information, Basic System Settings, Startup Configuration, Onboard Device Configuration, System Security and Load Default Settings.

To enter a menu, highlight the item using the ↑↓ keys; then press **Enter**.

Within a menu, navigate through the BIOS Setup Utility by following these instructions:

- Press the cursor up/down keys (↑↓) to move between parameters.
- Press the cursor left/right keys (→←) to change the value of a parameter.
- Press **Esc** while you are in any of the menu options to return to the main menu

NOTE: You can change the value of a parameter if it is enclosed in square brackets.

NOTE: Navigation keys for a particular menu are shown at the bottom of the screen.

System Information

The System Information screen displays a summary of your computer hardware information.

System Information		Page 1/1
CPU Type & Speed -----	[Celeron 400 Mhz]	
Floppy Disk Drive-----	[1.44 MB 3.5-inch]	
Hard Disk (MB) -----	[4645 MB]	
HDD Serial Number-----	[XXXXXXXXXXXXXXXXXXXXXX]	
System with-----	[CD-ROM Attached]	
System BIOS Version-----	[V3.0R01-A3C]	
VGA BIOS Version-----	[V3.0R01-A3C]	
Serial Number-----	[XXXXXXXXXXXXXXXXXXXXXXXXXXXXXXXXXXXX]	
Asset Tag Number-----	[XXXXXXXXXXXXXXXXXXXXXXXXXXXXXXXXXXXX]	
Product Name-----	[XXXXXXXXXXXXXXXXXXXXXXXXXXXXXXXXXXXX]	
Manufacturer Name-----	[XXXXXXXXXXXXXXXXXXXX]	
UUID-----	[XXXXXXXX-XXXX-XXXX-XXXX-XXXXXXXXXX]	
↑↓ = Move highlight bar, ←→ = Change setting, F1 = Help		

The table below describes the parameters in this screen.

Parameter	Description
CPU Type & Speed	Describes the type of CPU installed in the system.
Floppy Disk Drive	Shows the floppy disk drive type (1.44MB 3.5-inch).
Hard Disk (MB)	Sets the hard disk type.
HDD Serial Number	Shows the hard disk drive serial number.
System with	Shows the high-capacity disc drive installed.
System BIOS Version	Shows the system BIOS version.
VGA BIOS Version	Shows the video graphics accelerator BIOS version.
Serial Number	Shows the serial number of the system.
Asset Tag Number	Shows the asset tag number.
Product Name	Shows the official name of the product.
Manufacturer Name	Shows the name of the manufacturer.
UUID	Shows the universally unique identifier number.

Serial Number

The Serial Number is the number identical to the system serial number labelled at the bottom of system unit. The default Serial Number is scanned while manufacturing and stored to the **LCD inverter**. While service engineers swapping invertors for customers, they should re-input the original Serial Number to the system. Or this field in BIOS Setup will be in blank. To change the Serial Number field, please refer to "System Utility Diskette" in chapter 2 for more information .

Asset Tag Number

The default setting is empty. Customers can input into the Notebook Manager (setting by themselves whatever the number they need but only can input once) . While service engineers swapping **inverters** for customers, customers can re-input.

Product Name

It is the default setting as the brand name + model name of Acer product; such as TravelMate 505. "Product Name" will be automatically created by using **505Util.zip**.

Manufacture Name

The default setting is Acer. "Manufacture Name" will be automatically generated by using **505Util.zip**.

UUID

It stands for "Universally Unique IDentifiers", also known as GUID (Globally Unique Identifier). The requirement specification of **SMBIOS 2.1** (System Management BIOS). UUID are fixed-size 128-bit value and are unique across both space and time. The currently-used algorithm that was created by the OSF (Open Software Foundation) from a combination of a timestamp, physical Ethernet address, and a sequence number to generate the **unique ID number until the year A.D. 3400**. Without a network card machine, a different method is used to generate that part of the GUID. It differs from Intel number which identifies a computer, but UUID number can identify a person and even confidential documents user created.

To automatically generate a UUID, please refer to "System Utility Diskette" in chapter 2 for more information.

NOTE: The "Serial Number", "Asset Tag Number", "Product Name", "Manufacture Name" and "UUID" are located in the LCD inverter.

Basic System Configuration

The Basic System Configuration screen contains parameters involving basic computer settings like date and time.

Basic System Configuration		Page 1/1
Date-----	[Mon Aug 28, 1998]	
Time-----	[12:00:00]	
↑↓ = Move highlight bar, ←→ = Change setting, F1 = Help		

The table below describes the parameters in the screen.

Parameter	Description
Date	Sets the system date. Format: DDD MMM DD YYYY (day-of-the-week month day year)
Time	Sets the system time. Format: HH:MM:SS (hour:minute:second)

Startup Configuration

The Startup Configuration screen contains parameters that are related to computer startup.

Startup Configuration		Page 1/1
Boot Display -----	[AUTO]	
Screen Expansion -----	[Enabled]	
Hotkey Beep -----	[Enabled]	
Fast Boot -----	[Enabled]	
Boot Drive Sequence:		
1st -----	[Floppy Disk]	
2nd -----	[CD-ROM]	
3rd -----	[Hard Disk]	
↑↓ = Move highlight bar, ←→ = Change setting, F1 = Help		

The table below describes the parameters in this screen. Settings in boldface are the default and suggested parameter settings.

Parameter	Description
Boot Display	Sets the display on boot-up. When set to Auto, the computer automatically determines the display device. If an external display device (e.g., monitor) is connected, it becomes the boot display; otherwise, the computer LCD is the boot display. When set to Both, the computer outputs to both the computer LCD and an external display device if one is connected. Options: Auto or Both
Screen Expansion	When set to enabled, the screen will automatically adjust the display to fit the screen when the resolution is set 640 X 480. Options: Enabled or Disabled
Hotkey Beep	When enabled, the computer gives off a beep when a hotkey (key combination) is pressed. See "Hot Keys" on page 5 for details on hotkeys. Options: Enabled or Disabled
Fast Boot	Allows you to define your system's booting process, whether to skip some POST routines or proceed with the normal booting process. Options: Enabled or Disabled
Boot Drive Sequence	Allows you to set the sequence wherein the computer will boot 1st, 2nd, and so on. Below are possible boot devices.
Boot from CD-ROM	Enables boot-up from the CD-ROM drive, if selected as the first option. The computer attempts to boot from the CD-ROM drive (looks for a bootable CD-ROM) before following the boot sequence specified in the Boot Drive Sequence.
Floppy	Enables boot-up from the floppy disk drive, if selected as the first option. The computer attempts to boot from the floppy disk drive (look for a bootable floppy) before following the boot sequence specified in the Boot Drive Sequence.
Hard Disk	Enables boot-up from the hard disk drive.

Onboard Device Configuration

The Onboard Device Configuration screen contains parameter settings for your hardware connection devices.

Onboard Device Configuration		Page 1/1
Serial Port -----	[Enabled]	
Base Address -----	[3F8h]	
IRQ -----	[4]	
Parallel Port -----	[Enabled]	
Base Address -----	[378h]	
IRQ -----	[7]	
Operation Mode -----	[ECP]	
ECP DMA Channel -----	[1]	
↑↓ = Move highlight bar, ←→ = Change setting, F1 = Help		

CAUTION: The parameters in this screen are for advanced users only. You do not need to change the values in this screen because these values are already optimized.

The table below describes the parameters in this screen. Settings in boldface are the default and suggested parameter settings.

Parameter	Description
Serial Port	Enables or disables the serial port. Options: Enabled or Disabled
Base Address	Sets the I/O address of the serial port. Options: 3F8h , 2F8h, 3E8h or 2E8h
IRQ	Sets the interrupt request of the serial port. Options: 4 or 11
Parallel Port	Enables or disables the parallel port. Options: Enabled or Disabled
Base Address	Sets the I/O address of the parallel port. Options: 378h , 278h or 3BCh
IRQ	Sets the interrupt request of the parallel port. Options: 7 or 5
Operation Mode	Sets the operation mode of the parallel port. Options: ECP , EPP, Bidirectional or Standard
ECP DMA Channel	Sets a DMA channel for the printer to operate in ECP mode. This parameter is enabled only if Operation Mode is set to ECP. Options: 1 or 3

System Security

The System Security screen contains parameters that help safeguard and protect your computer from unauthorized use.

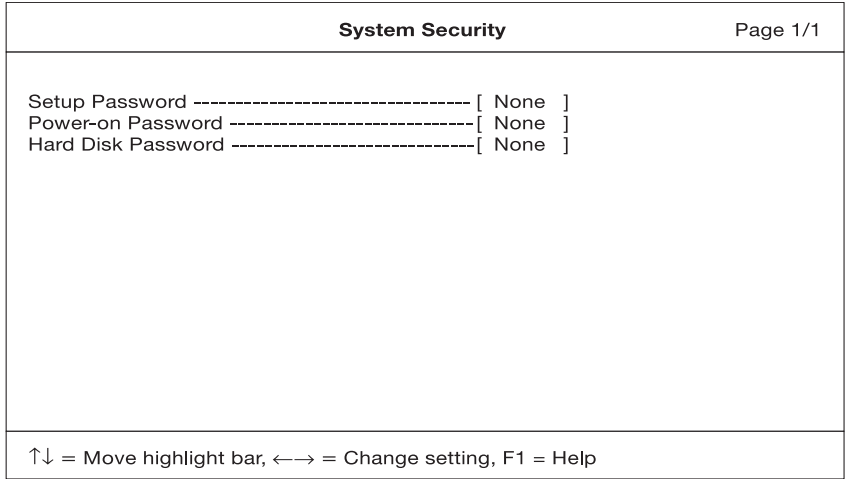

The table below describes the parameters in this screen. Settings in boldface are the default and suggested parameter settings.

Parameter	Description
Setup Password	When set, this password protects the BIOS Setup Utility from unauthorized entry. Options: None or Present
Power-on Password	When set, this password protects the computer from unauthorized entry during boot-up or resume from Hibernation mode. Options: None or Present
Hard Disk Password	When set, this password prevents the internal hard disk from unauthorized access. It consists of 8 alphanumeric characters. Options: None or Present

NOTE: Don't forget your password, if you forget your password, you may have to return your notebook computer to your dealer to reset it.

Setting a password

Follow these steps:

1. Use the ↑ and ↓ keys to highlight a password parameter (Setup, Power-on, or Hard Disk) and press the **Enter** key. The password box appears:



2. Type a password. The password may consist of up to eight alphanumeric characters (A-Z, a-z, 0-9).

IMPORTANT: Be very careful when typing your password because the characters do not appear on the screen.

3. Press **Enter**. The retype password box appears.



4. Retype the password to verify your first entry and press **Enter**.
- After setting the password, the computer automatically sets the chosen password parameter to Present.
5. Press **Esc** to return to the main menu.
 6. Press **Esc**. The following dialog box appears.

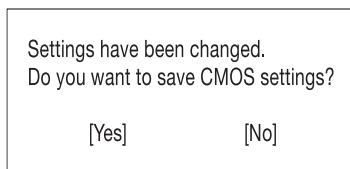

7. Select **Yes** and press **Enter** to save the password and exit the BIOS Setup Utility.

Changing a password







To change a password, follow the same steps used to set a password.

Removing a password

To remove a password, use the \uparrow and \downarrow keys to highlight a password parameter and press the “Enter” key as the first character.

Password icons

Below are the password icons and their descriptions:

Parameters	Description
Power-on Password icon 	When set to present, prompts the user to input the correct password for the system to continue. It is shown after the TravelMate logo.
Hard Disk Password icon 	When set to present, prompts the user to input the correct password for the hard disk to operate. It is shown after the Power-on Password Icon.
Password character icon 	When typing the characters of the password, the screen displays this icon for each character instead of the actual password character.
Wrong password icon 	If the wrong password is entered, this icon will be displayed beside the wrong password.
Successful password entry icon 	If the password is correctly entered, this icon will be displayed beside the correctly entered password.
Password failure icon 	The system allows the user 3 chances to type the correct password. After the password has been incorrectly entered 3 times, this icon will be displayed together with a short message stating “system shut-down”. The user then has to reboot the system to try to type the correct password again.

Load Default Settings

When you select this menu item, the following dialog box displays:

Do you want to load default settings?

[Yes] [No]

To load factory-default settings for all the parameters, select **Yes** and press **Enter**. Otherwise, select **No** and press **Enter**.

AFlash Utility

The BIOS flash memory update is required for the following conditions:

- New versions of system programs
- New features or options

Use the AFlash utility to update the system BIOS flash ROM.

NOTE: Do not install memory-related drivers (XMS, EMS, DPMS) when you use AFlash.

NOTE: This program contains a readme.txt file. This readme.txt file will introduce how to use AFlash utility.

Executing AFlash

IMPORTANT: If this diskette is not bootable, do the following actions before you use it:

1. Create a bootable disk.
2. Copy all AFlash files into this bootable diskette.
3. Put the bootable disk into TravelMate 505 series mobile, then re-boot.

IMPORTANT: Never turn off the system power while Flash BIOS is programming. This will damage your system.

4. After Flash BIOS is done, reboot the system.

NOTE: If any problems occurred during BIOS updated, refer to "Index of PQA Diagnostic Error Code, Message" on page 70 for troubleshooting.

System Utility Diskette

This utility diskette is for the Acer TravelMate 505 notebook machine. It provides the following functions:

1. Panel ID Utility
2. Thermal and Fan Utility
3. Mother Board Data Utility

To use this diskette, first boot from this diskette, then a "Microsoft Windows 98 Startup Menu" prompt you to choose the testing item. Follow the instructions on screen to proceed.

NOTE: This program contains a readme.txt file. This readme.txt file will introduce each test utility and its functions.

IMPORTANT: If this diskette is not bootable, do the following actions before you use it:

1. Do system transfers.
2. Copy HIMEM.SYS to A:\.
3. Copy EMM386.EXE to A:\

Panel ID Utility

There is an EEPROM in the inverter which stores its supported LCD type ID code. If you replace an LCD with one of a different brand or use a new inverter, the ID information in the inverter EEPROM should be updated.

Follow the steps below to see the LCD Panel ID:

1. Follow the instructions on-screen to read current or to set new LCD Panel ID code.

NOTE: When you set a new LCD Panel ID and the new LCD is not yet enabled (to function), connect an external CRT to see the program execution process.

NOTE: Make sure the new ID code you choose corresponds with the LCD brand and type. If you write a wrong ID into the inverter, just reboot and re-execute the program and input the correct ID code.

2. Restart the computer - the new LCD should work normally.

NOTE: If LCD cannot display after changing the ID code, make sure you select the correct ID code, or try reconnecting the LCD FPC cable connectors.

Thermal and Fan Utility

The system is equipped with sensors to protect against system overheating. By setting system and processor thermal thresholds, the system can turn on the cooling fan or shut down automatically when temperatures reach the defined threshold parameters. This utility will test fan, processor thermal and system thermal.

Mainboard Data Utility

This utility will display Mainboard Data (MBD) which includes header information, product name, manufacture name, UUID (Universally Unique Identifiers) and serial number. This function can display and create MBD data as well as store those information to LCD inverter EEPROM (not flash ROM). Following are specification for this function.

1. Read mother board data can display the MBD data.
2. Create MBD header information, product name and manufacture name can create 3 informations and write them to EEPROM automatically.
3. Write MBD UUID can create and write a new UUID. This function is used when the original UUID is lost or damaged. Use "Read Mother Board Data" first to keep the UUID.
4. Write MBD serial number can keyin MBD serial number by user.

System Diagnostic Diskette

IMPORTANT: The diagnostics program here that we used is called PQA (Product Quality Assurance) and is provided by Acer Headquarters. You can utilize it as a basic diagnostic tool. To get this program, either download it from <http://csd.acer.com.tw> or find it in the TravelMate 505 service CD kit. To better fit local service requirements, your regional office MAY have other diagnostic program. Please contact your regional offices or the responsible personnel/channel to provide you with further technical details.

NOTE: This program contains a readme.txt file. This readme.txt file will introduce each test and its functions.

This diagnostic program divided into two diskettes is for the Acer TravelMate 505 notebook machine. It provides the following functions:

1. PQA System Diagnostics
2. Audio Resource and Speaker Out Test
3. USB Register and Connect / Disconnect Test

NOTE: A USB device is required when executing the USB Connection / Disconnection Test, or this test fails.

4. Exit

To use this diskette, first boot from this diskette, then a "Microsoft Windows 98 Startup Menu" prompts you to choose the testing item. Follow the instructions on screen to proceed.

IMPORTANT: This diskette is not bootable, do the following actions before you use it:

1. Do system transfers.
2. Copy the following files to A:\
HIMEM.SYS
RAMDRIVE.SYS
LASTDRV.COM
MSCDEX.EXE

NOTE: When executing a parallel or serial port test in System Test item, a loopback tool is needed. This loopback is Acer proprietary design. You may reach the computerhwdoctor@acer.com.tw for ordering information.

Running PQA Diagnostics Program.

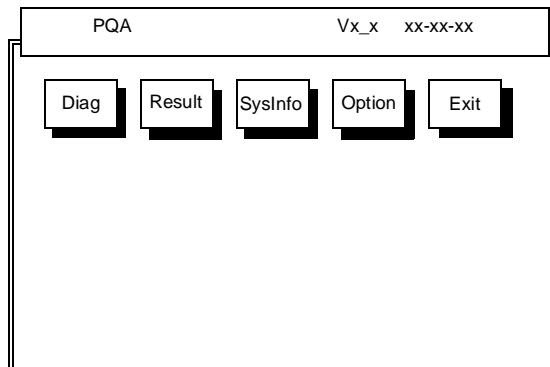

Press →← to move around the main menu. Press Enter to enable the selected option. The main options are Diag, Result, SysInfo, Option and Exit.

The Diag option lets you select testing items and times.

The following screen appears when you select Diag from the main menu.

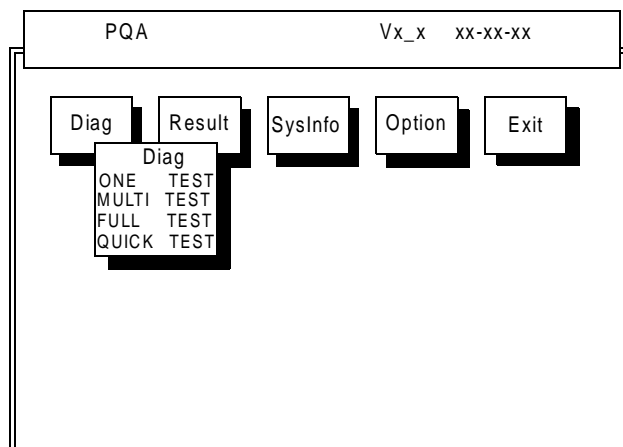

One Test Performs a single test and manual checks the selected test items in sequence.

Multi Test Performs multiple tests and manual checks the selected test items in sequence.

Full Test Performs all items and full check the all test items in sequence.

Quick Test Performs special tests of the highlighted items and quickly check the selected test items in sequence.

The screen below appears if you select Multi Test.

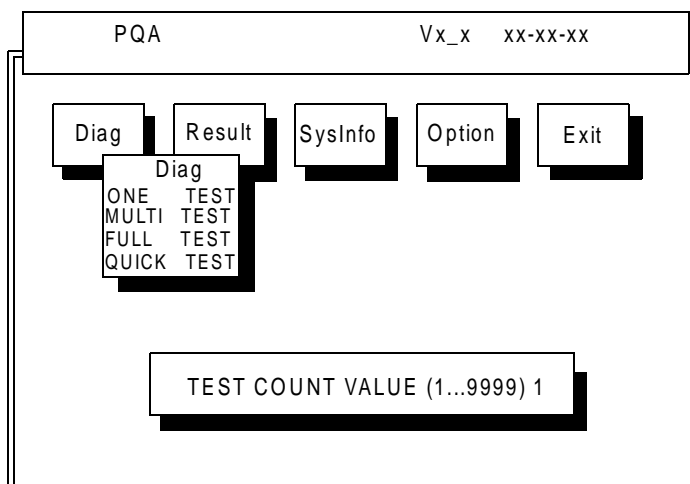

Specify the desired number of tests and press **Enter**.

After you specify the number of tests to perform, the screen shows a list of test items (see below):

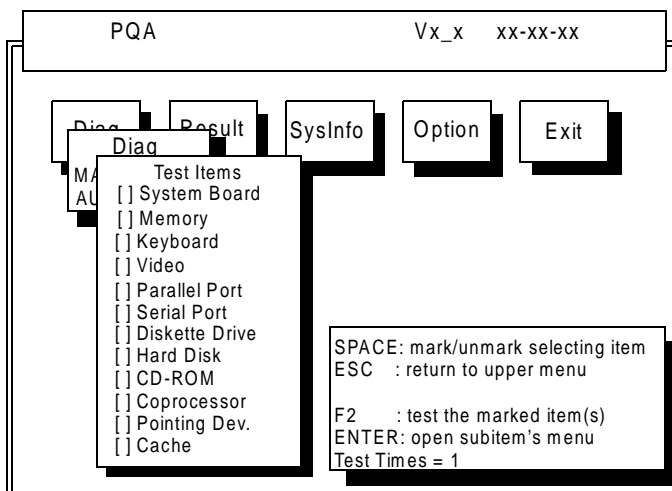

Move the highlight bar from one item to another. Press a space to mark or unmark the item. Press **Enter** to open the subitem menu. Press **Esc** to close the submenu.

The right corner screen information gives you the available function keys and the specified test number.

- Space: mark/unmark selecting item
- ESC: return to upper menu
- F1: help menu
- F2: tests the marked item(s)
- Enter: Open subitem's menu
- Test Times: Indicates the number of tests to perform

NOTE: The F1 and F2 keys function only after you finish configuring the Test option.

NOTE: If there are any problems occurred during BIOS updated, refer to "Index of PQA Diagnostic Error Code, Message" on page 70 for troubleshooting.

Machine Disassembly and Replacement

This chapter contains step-by-step procedures on how to disassemble the notebook computer for maintenance and troubleshooting.

To disassemble the computer, you need the following tools:

- Wrist grounding strap and conductive mat for preventing electrostatic discharge
- Flat-bladed screwdriver
- Phillips screwdriver
- Tweezers
- Flat-bladed screwdriver or plastic stick

NOTE: The screws for the different components vary in size. During the disassembly process, group the screws with the corresponding components to avoid mismatch when putting back the components.

General Information

Before You Begin

Before proceeding with the disassembly procedure, make sure that you do the following:

1. Turn off the power to the system and all peripherals.
2. Unplug the AC adapter and all power and signal cables from the system.
3. Remove the battery pack.

Connector Types

There are two kinds of connectors on the system board:

- Connectors with no locks
Unplug the cable by simply pulling out the cable from the connector.
- Connectors with locks
You can use a plastic stick to lock and unlock connectors with locks.

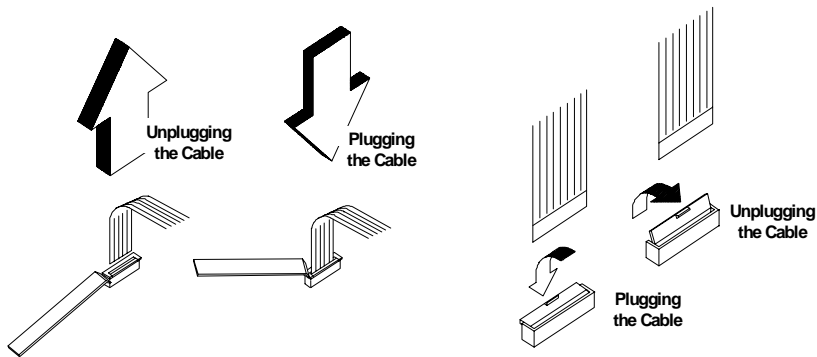

Unplugging the cable with locks

To unplug the cable, first unlock the connector by pulling up the two clasps on both sides of the connector with a plastic stick. Then carefully pull out the cable from the connector.

Plugging the cable with locks

To plug the cable back, first make sure that the connector is unlocked, then plug the cable into the connector. With a plastic stick, press the two clasps on both sides of the connector to secure the cables in place.

NOTE: The cables used here are special FPC (flexible printed-circuit) cables and more delicate than normal plastic-enclosed cables. Do not force cables out of the connectors to prevent damage.

Disassembly Procedure Flowchart

The flowchart on the succeeding page gives you a graphic representation on the entire disassembly sequence and instructs you on the components that need to be removed during servicing. For example, if you want to remove the system board, you must first remove the keyboard, then disassemble the inside assembly frame in that order.

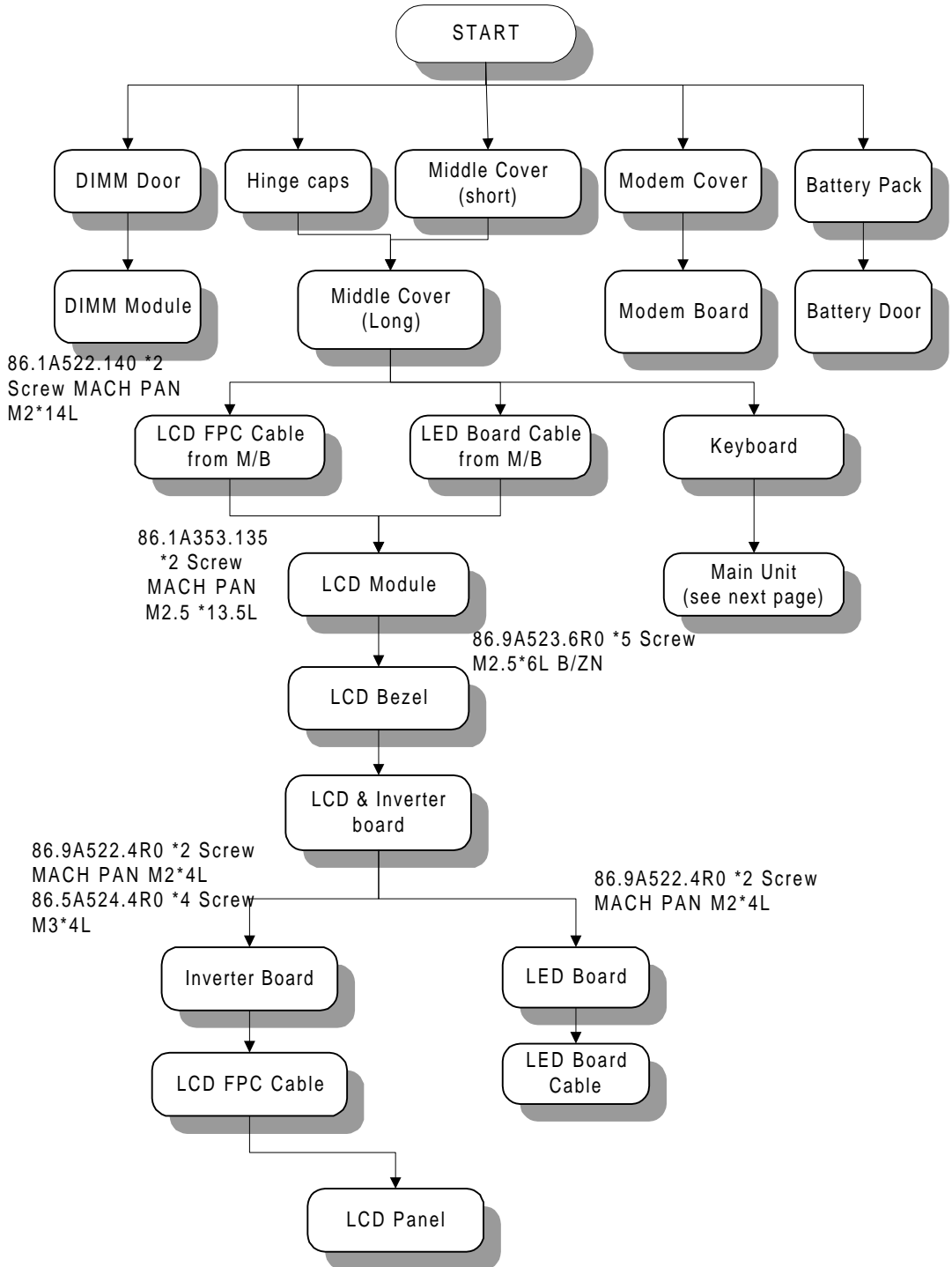

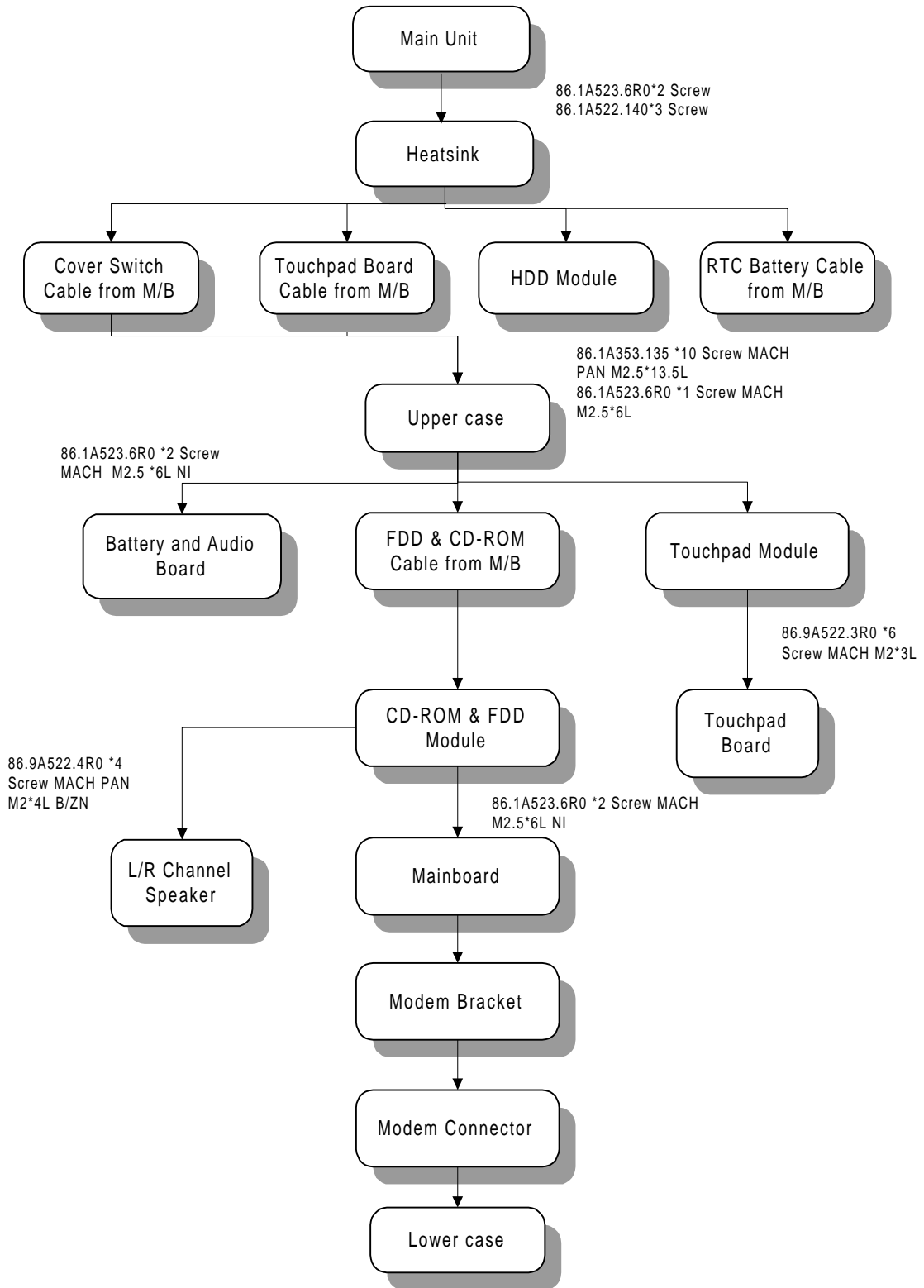

Removing the Battery Pack

1. Press the battery cover release latch down and slide the battery pack out from the main unit.
2. Remove the battery cover from the battery pack carefully.



Removing the DIMM

1. To remove the DIMM module, remove the two screws from the DIMM cover.
2. Then, remove the DIMM cover from the lower case.



3. Use two flat-bladed screwdrivers to push the latches outward on both sides of the DIMM socket.
4. Then, remove the extended DIMM module from the DIMM socket.



Removing the Modem Board

1. To remove the modem board, first remove the screw from the modem cover.
2. Remove the modem cover from the lower case.

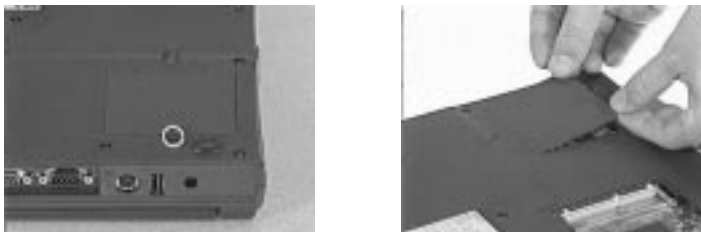

3. At CN20, remove the modem board from the mainboard.
4. Disconnect the modem power cable from the modem board.

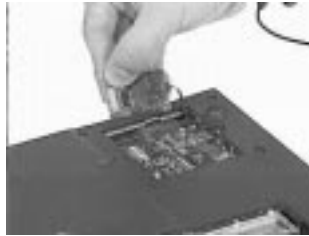

Removing the Keyboard

1. Slide out the right and left hinge cover from the main unit.
2. Use a flat-bladed screwdriver to remove the short middle cover.



3. Slide the long middle cover to the left side then remove it from the upper case.



4. Pull out and upward to expose the keyboard connector at CN19, and disconnect the keyboard cable from the keyboard connector carefully.

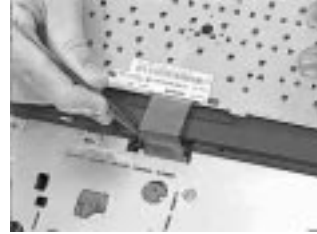

Removing the LCD Module

1. Remove the two screws holding the LCD FPC cable
2. At CN9, disconnect the LCD FPC cable from the mainboard.

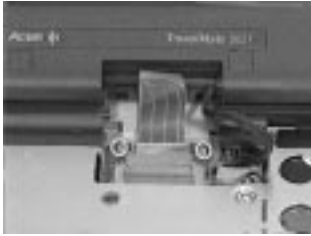

3. At CN7, disconnect the LED cable from the mainboard.



4. Remove the two screws holding the LCD module as shown.
5. Next, remove the LCD module from the main unit.



Disassembling the LCD

1. Remove the two rubber LCD cushions and the 3 hinge screw caps from the LCD module.

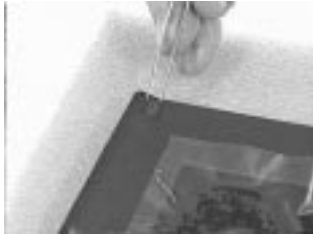

2. Remove the five screws from the LCD module, and snap out the LCD bezel.
3. Then, remove it from the LCD module.

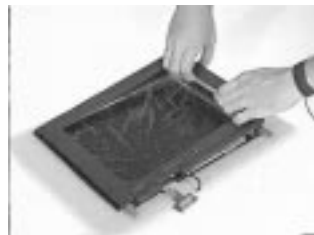

4. Remove the two screws holding the LED board, and remove the LED board from the LCD panel.
5. Disconnect the LED cable from the LED board.



6. Remove the four screws holding the two LCD hinges, then remove the hinges.



-
7. Remove the two screws holding the inverter. Now, lift off the inverter gently.

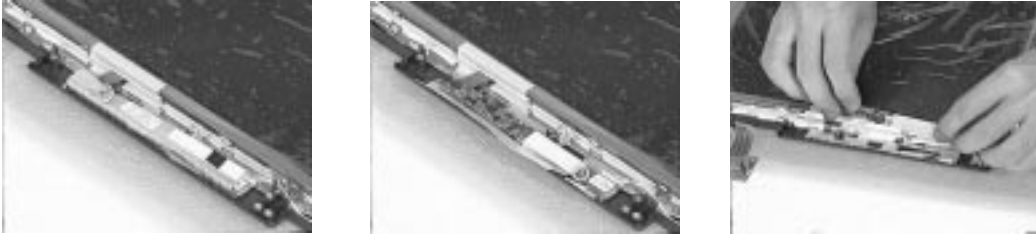

8. Disconnect the LCD power cable and LCD FPC cable from the inverter board.



9. Remove the four screws holding the LCD, then gently remove the LCD from the LCD panel.

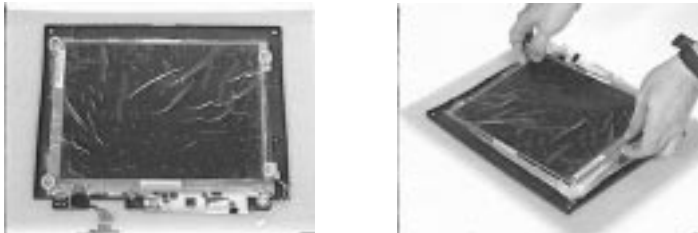

10. Tear off the adhesive tape.

11. Disconnect the LCD FPC cable from the LCD.



Disassembling the Main Unit

Removing the Heatsink and CPU EMI Shield

1. Remove the five screws holding the system heatsink.
2. Slide the heatsink to the left side and take it out from the main unit.



3. Remove the CPU EMI shield from the main unit.
4. At CN8, disconnect the RTC battery cable from the mainboard and then lift it away from the upper case.



Removing the Hard Disk Drive

1. At CN17, remove the hard disk drive from the mainboard.

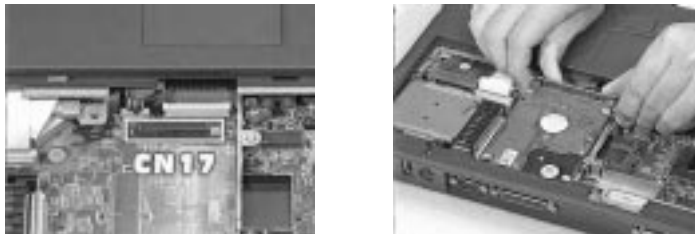

2. At CN18, disconnect the touchpad cable from the mainboard.

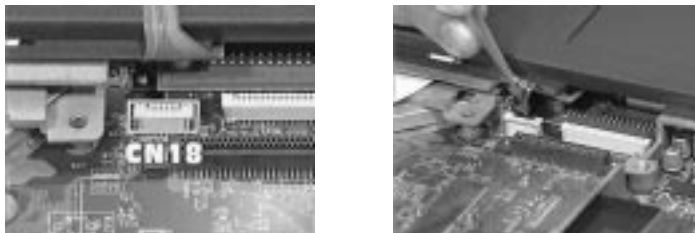

Removing Upper Case

1. To release the upper case, first remove the eleven screws from the main unit.
2. Lift the upper case gently.



3. At CN6, disconnect the cover switch cable from the mainboard, then remove the upper case.



Removing the Floppy Disk Drive/CD-ROM Drive Combo Module

1. Disconnect the CD-ROM drive cable and floppy disk drive cable at CN16 and CN 15 respectively.



2. Remove the screw shown here.
3. Remove the CD-ROM drive screw cap from the bottom of the main unit.
4. Remove the screw shown here.



5. Now, remove the floppy disk drive and CD-ROM drive combo module from the main unit.



Removing the Speakers

1. Disconnect the left and right speaker cables from the audio I/O and battery connection board at CN1 and CN2 respectively.



2. Remove the four screws holding the two speakers, then remove the two speakers from the lower case.



Removing the Audio I/O and Battery Connection Board

1. Remove the two screws holding the audio I/O and battery connection board, then remove it from the mainboard.



Removing the Fan

1. Disconnect the fan cable from the mainboard.
2. Remove the two screws holding the fan, then lift the fan from the lower case.



Removing the Mainboard

1. Remove the two screws holding the mainboard, then remove the mainboard from the lower case.
2. Remove the modem phone jack connector from the lower case.



Removing the PCMCIA Card

1. Remove the four screws holding the PCMCIA slot.
2. At CN13, disconnect the PCMCIA slot from the mainboard.

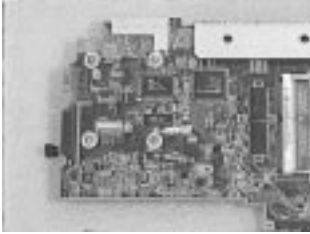

Removing the Touchpad Module

1. To remove the touchpad module, first release the touchpad cable from the position shown here.
2. Remove the six screws holding the touchpad bracket.
3. Now, lift the touchpad module away from the upper case.

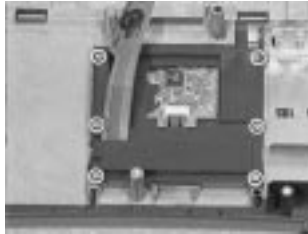

4. Disconnect the touchpad cable from the touchpad board, then remove the touchpad bracket.

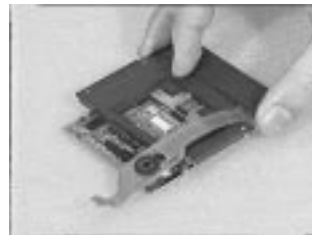

Disassembling the Hard Disk Drive Module

1. To disassemble the hard disk drive module, first remove the six screws as shown here.

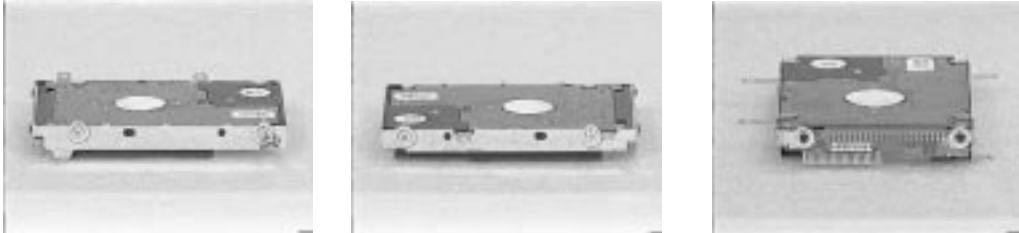

2. Detach the left and right brackets from the hard disk drive.
3. Remove the hard disk drive connection board from the hard disk drive.

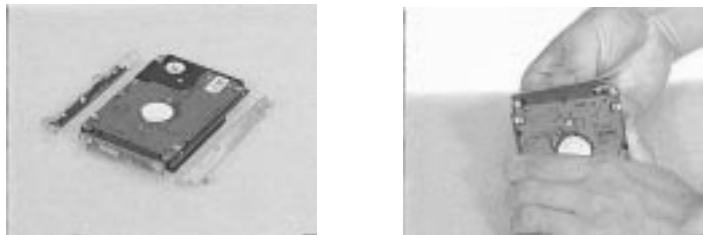

Disassembling the Floppy Disk Drive and CD-ROM Combo Module

1. To disassemble the CD-ROM drive from the combo module, first remove the three screws as shown here..

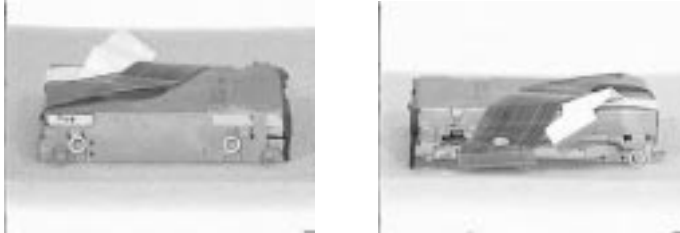

2. Disconnect the CD-ROM FPC cable, then slide out the CD-ROM drive from the chassis.
3. Remove the CD-ROM FPC cable from the chassis.



4. To remove the floppy disk drive from the combo module, first remove the three screws as shown here.

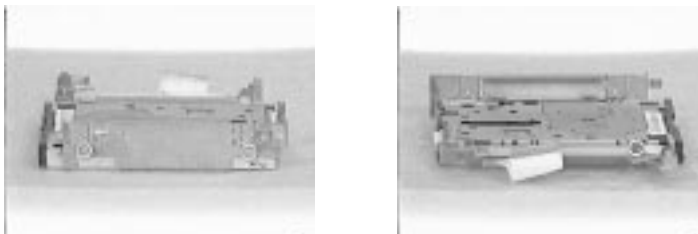

5. Remove the floppy disk drive from the chassis.
6. Disconnect the floppy disk drive FPC cable from the floppy disk drive.



Troubleshooting

Use the following procedure as a guide for computer problems.

NOTE: The diagnostic tests are intended to test only Acer products. Non-Acer products, prototype cards, or modified options can give false errors and invalid system responses.

1. Obtain the failing symptoms in as much detail as possible.
2. Verify the symptoms by attempting to re-create the failure by running the diagnostic test or by repeating the same operation.
3. Use the following table with the verified symptom to determine which page to go to.

Symptoms (Verified)	Go To
Power failure. (The power indicator does not go on or stay on.)	Power System check
POST does not complete. No beep or error codes are indicated.	Symptom-to-FRU Index Undetermined Problems
POST detects an error and displayed messages on screen.	Error Messages List
The diagnostic test detected an error and displayed a FRU code.	Running PQA Diagnostic Program
Other symptoms (i.e. LCD display problems or others).	Error Symptom-to-FRU Index
Symptoms cannot be re-created (intermittent problems).	Use the customer-reported symptoms and go to Error Symptom-to-FRU Index. Intermittent Problems Undetermined Problems

System Check Procedures

Diskette Drive Check

Do the following to isolate the problem to a controller, driver, cable or diskette. A write-enabled, diagnostic diskette is required.

NOTE: Make sure that the diskette does not have more than one label attached to it. Multiple labels can cause damage to the drive or cause the drive to fail.

Do the following to select the test device.

1. Boot from the diagnostics diskette and start the PQA program.
2. Go to the diagnostic Diskette Drive in the test items.
3. Press F2 in the test items.
4. Follow the instructions in the message window.

If an error occurs with the internal diskette drive, reconnect the diskette connector on the system board.

If the error still remains:

1. Reconnect the diskette drive.
2. Replace the diskette driver cable.
3. Replace the diskette drive.
4. Replace the system board.

CD-ROM Drive Check

Do the following to isolate the problem to a controller, drive, cable, or CD-ROM. Make sure that the CD-ROM does not have any label attached to it. The label can cause damage to the drive or can cause the drive to fail.

Do the following to select the test device:

1. Boot from the diagnostics diskette and start the PQA program.
2. Go to the diagnostic CD-ROM in the test items.
3. Press F2 in the test items.
4. Follow the instructions in the message window.

If an error occurs, reconnect the connector on the System board. If the error still remains:

1. Reconnect the CD-ROM drive.
2. Replace the diskette driver cable.
3. Replace the CD-ROM drive.
4. Replace the system board.

Keyboard or Auxiliary Input Device Check

Remove the external keyboard if the internal keyboard is to be tested.

If the internal keyboard does not work or an unexpected character appears, make sure that the flexible cable extending from the keyboard is correctly seated in the connector on the system board.

If the keyboard cable connection is correct, run the Keyboard Test. See "Running the Diagnostics" for details.

If the tests detect a keyboard problem, do the following one at a time to correct the problem. (Do not replace a non-defective FRU):

1. Reconnect the keyboard cables.
2. Replace the keyboard.
3. Replace the system board.

The following auxiliary input devices are supported by this computer:

- Numeric keypad
- External keyboard

If any of these devices do not work, reconnect the cable connector and repeat the failing operation.

Memory Check

Memory errors might stop system operations, show error messages on the screen, or hang the system.

1. Boot from the diagnostics diskette and start the PQA program (please refer to “Running PQA Diagnostics Program”).
2. Go to the diagnostic memory in the test items.
3. Press F2 in the test items.
4. Follow the instructions in the message window.

NOTE: Make sure that the DIMM is fully installed into the connector. A loose connection can cause an error.

Power System Check

To verify the symptom of the problem, power on the computer using each of the following power sources:

1. Remove the battery pack.
2. Connect the power adapter and check that power is supplied.
3. Disconnect the power adapter and install the charged battery pack; then check that power is supplied by the battery pack.

If you suspect a power problem, see the appropriate power supply check in the following list:

- “Check the Power Adapter”
- “Check the Battery Pack”

Check the Power Adapter

Unplug the power adapter cable from the computer and measure the output voltage at the plug of the power adapter cable. See the following figure

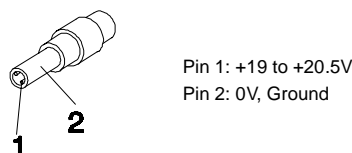

1. If the voltage is not correct, replace the power adapter.
2. If the voltage is within the range, do the following:
 - Replace the System board.
 - If the problem is not corrected, see “Undetermined Problems”.
 - If the voltage is not correct, go to the next step.

NOTE: An audible noise from the power adapter does not always indicate a defect.

3. If the power problem occurs only when the port replicator is used, replace the port replicator.
4. If the power-on indicator does not light up, check the power cord of the power adapter for correct continuity and installation.
5. If the operational charge does not work, see “Check the Battery Pack”.

Check the Battery Pack

To check the battery pack, do the following:

1. Power off the computer.
2. Remove the battery pack and measure the voltage between battery terminals 2(+) and 7(ground). See the following figure

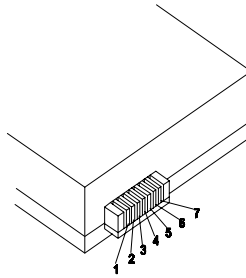

3. If the voltage is still less than 8.0 Vdc after recharging, replace the battery.

To check the battery charge operation, use a discharged battery pack or a battery pack that has less than 50% of the total power remaining when installed in the computer.

If the battery status indicator does not light up, remove the battery pack and let it return to room temperature. Re-install the battery pack.

If the charge indicator still does not light up, replace the battery pack. If the charge indicator still does not light up, replace the system board.

Touchpad Check

If the touchpad doesn't work, do the following actions one at a time to correct the problem. Do not replace a non-defective FRU:

1. Reconnect the touchpad cables.
2. Replace the touchpad.
3. Replace the system board.

After you use the touchpad, the pointer drifts on the screen for a short time. This self-acting pointer movement can occur when a slight, steady pressure is applied to the touchpad pointer. This symptom is not a hardware problem. No service actions are necessary if the pointer movement stops in a short period of time.

Index of Error Message

The symptom-to-FRU index lists the symptoms and errors and their possible causes. The most likely cause is listed first.

NOTE: Perform the FRU replacement or actions in the sequence shown in FRU/Action column, if the FRU replacement does not solve the problem, put the original part back in the computer. Do not replace a non-defective FRU.

This index can also help you determine the next possible FRU to be replaced when servicing a computer.

If the symptom is not listed, see “Undetermined Problems” on page 69.

The following lists the error messages that the BIOS displays on the screen and the error symptoms classified by function.

NOTE: Most of the error messages occur during POST. Some of them display information about a hardware device, e.g., the amount of memory installed. Others may indicate a problem with a device, such as the way it has been configured.

NOTE: If the system fails after you make changes in the BIOS Setup Utility menus, reset the computer, enter Setup and install Setup defaults or correct the error

Error Messages List

Error Messages	Action in Sequence
Failure Fixed Disk	Reconnect hard disk drive connector. “Load Default Settings” in BIOS Setup Utility. Hard disk drive System board
Stuck Key	“Keyboard or Auxiliary Input Device Check” .
Keyboard error	“Keyboard or Auxiliary Input Device Check”.
Keyboard Controller Failed	“Keyboard or Auxiliary Input Device Check”.
Keyboard locked - Unlock key switch	Unlock external keyboard.
Monitor type does not match CMOS - Run Setup	Run “Load Default Settings” in BIOS Setup Utility.
Shadow RAM Failed at offset: nnnn	BIOS ROM System board
System RAM Failed at offset: nnnn	DIMM System board
Extended RAM Failed at offset: nnnn	DIMM System board
System battery is dead - Replace and run Setup	Replace RTC battery and Run BIOS Setup Utility to reconfigure system time, then reboot system.
System CMOS checksum bad - Default configuration used	RTC battery Run BIOS Setup Utility to reconfigure system time, then reboot system.
System timer error	RTC battery Run BIOS Setup Utility to reconfigure system time, then reboot system. System board
Real time clock error	RTC battery Run BIOS Setup Utility to reconfigure system time, then reboot system. System board
Previous boot incomplete - Default configuration used	Run “Load Default Settings” in BIOS Setup Utility. RTC battery System board

Error Messages List

Error Messages	Action in Sequence
Memory size found by POST differed from CMOS	Run "Load Default Settings" in BIOS Setup Utility. DIMM System board
Diskette drive A error	Check that the drive is defined with the proper diskette type in BIOS Setup Utility. Diskette Drive Check.
Incorrect Drive A type - run SETUP	Check that the drive is defined with the proper diskette type in BIOS Setup Utility Diskette Drive Check.
System cache error - Cache disabled	CPU board System board
CPU ID	CPU board System board
DMA Test Failed	DIMM CPU board System board
Software NMI Failed	DIMM CPU board System board
Fail-Safe Timer NMI Failed	DIMM CPU board System board
Device Address Conflict	Run "Load Default Settings" in BIOS Setup Utility. RTC battery System board
Allocation Error for device	Run "Load Default Settings" in BIOS Setup Utility. RTC battery System board
Failing Bits: nnnn	DIMM BIOS ROM System board
Fixed Disk n	None
Invalid System Configuration Data	BIOS ROM System board
I/O device IRQ conflict	Run "Load Default Settings" in BIOS Setup Utility. RTC battery System board
Operating system not found	Enter Setup and see if fixed disk and drive A are properly identified. Diskette drive Hard disk drive System board

No-Beep Symptoms

Symptom / Error	Action in Sequence
No beep, power-on indicator turns off and LCD is blank.	Power source (battery pack and power adapter). Power System Check. Ensure every connector is connected tightly and correctly. Reconnect the DIMM. CPU board DC-DC/charger board System board.
No beep, power-on indicator turns on and LCD is blank.	Power source (battery pack and power adapter). Power System Check. Reconnect the LCD connectors Hard disk drive LCD inverter ID LCD FPC cable Inverter LCD System board
No beep, power-on indicator turns on and LCD is blank. But you can see POST on an external CRT.	Reconnect the LCD connectors. LCD inverter ID LCD FPC cable LCD inverter LCD System board
No beep, power-on indicator turns on and a blinking cursor shown on LCD during POST.	Ensure every connector is connected tightly and correctly. System board
No beep during POST but system runs correctly.	Speaker Audio/Battery connection board System board

Index of Symptom-to-FRU Error Message

LCD-Related Symptoms

Symptom / Error	Action in Sequence
LCD backlight doesn't work LCD is too dark LCD brightness cannot be adjusted LCD contrast cannot be adjusted	Enter BIOS Utility to execute "Load Setup Default Settings", then reboot system. Reconnect the LCD connectors. Keyboard (if contrast and brightness function key doesn't work). LCD inverter ID LCD FPC cable LCD inverter LCD System board
Unreadable LCD screen Missing pels in characters Abnormal screen Wrong color displayed	Reconnect the LCD connectors. LCD inverter ID LCD FPC cable LCD inverter LCD System board
LCD has extra horizontal or vertical lines displayed.	LCD inverter ID LCD inverter LCD FPC cable LCD System board

Indicator-Related Symptoms

Symptom / Error	Action in Sequence
Indicator incorrectly remains off or on, but system runs correctly.	Reconnect the LED board LED board System board

Power-Related Symptoms

Symptom / Error	Action in Sequence
Power shuts down during operation.	Power source (battery pack and power adapter). Power System Check. Battery pack Power adapter Audio-I/O & battery connection board System board
The system doesn't power-on.	Power source (battery pack and power adapter). Power System Check. Battery pack Power adapter Audio-I/O & battery connection board System board
The system doesn't power-off.	Power source (battery pack and power adapter). Power System Check. Hold and press the power switch for more than 4 seconds. System board

Power-Related Symptoms

Symptom / Error	Action in Sequence
Battery can't be charged	Power System Check Battery pack System board

PCMCIA-Related Symptoms

Symptom / Error	Action in Sequence
System cannot detect the PC Card (PCMCIA)	PCMCIA slot assembly System board
PCMCIA slot pin is damaged.	PCMCIA slot assembly

Memory-Related Symptoms

Symptom / Error	Action in Sequence
Memory count (size) appears different from actual size.	Enter BIOS Setup Utility to execute "Load Default Settings, then reboot system. DIMM System board

Speaker-Related Symptoms

Symptom / Error	Action in Sequence
In DOS or Windows, multimedia programs, no sound comes from the computer.	Press Fn-F8, Speaker ON/OFF control. Audio driver Speaker Audio/Battery connection board System board
Internal speakers make noise or emit no sound.	Press Fn-F8, Speaker ON/OFF control. Speaker Audio/Battery connection board System board

Power Management-Related Symptoms

Symptom / Error	Action in Sequence
The system will not enter hibernation	Keyboard (if control is from the keyboard) Hard disk drive System board Check with Sleep Manager.
The system doesn't enter hibernation mode and four short beeps every minute.	Hibernation Mode Press Fn+F4 and see if the computer enters hibernation mode. Touchpad Keyboard Hard disk connection board Hard disk drive System board
The system doesn't enter standby mode after closing the LCD	Standby Mode LCD cover switch System board
The system doesn't resume from hibernation mode.	Hibernation Mode Hard disk connection board Hard disk drive System board

Power Management-Related Symptoms

Symptom / Error	Action in Sequence
The system doesn't resume from standby mode after opening the LCD.	Standby Mode LCD cover switch System board
Battery fuel gauge in Windows doesn't go higher than 90%.	Remove battery pack and let it cool for 2 hours. Refresh battery (continue to use battery until power off, then charge battery). Battery pack Charger board System board
System hangs intermittently.	Set Thermal Sensor Threshold. Reconnect hard disk/CD-ROM drives. Hard disk connection board System board

Peripheral-Related Symptoms

Symptom / Error	Action in Sequence
System configuration does not match the installed devices.	Enter BIOS Setup Utility to execute "Load Default Settings", then reboot system. Reconnect hard disk/CD-ROM/diskette drives.
External display does not work correctly.	Press Fn+F5, LCD/CRT/Both display switching Running PQA Diagnostics Program. System board
USB does not work correctly.	System Diagnostics Diskette System board
Print problems.	Ensure that the "Parallel Port" in the "Onboard Devices Configuration" of BIOS Setup Utility is set to Enabled. Onboard Devices Configuration Run printer self-test. Printer driver Printer cable Printer System Board
Serial or parallel port device problems.	Ensure that the "Serial Port" in the "Onboard Devices Configuration" of BIOS Setup Utility is set to Enabled. Device driver Device cable Device System board

Keyboard/Touchpad-Related Symptoms

Symptom / Error	Action in Sequence
Keyboard (one or more keys) does not work.	Reconnect the keyboard cable. Keyboard System board
Touchpad does not work.	Reconnect touchpad cable. Touchpad board System board

Modem-Related Symptoms

Symptom / Error	Action in Sequence
Internal modem does not work correctly.	System Diagnostics Diskette Modem phone jack Modem board System board

NOTE: If you cannot find a symptom or an error in this list and the problem remains, see "Undetermined Problems" on page 69.

Intermittent Problems

Intermittent system hang problems can be caused by a variety of reasons that have nothing to do with a hardware defect, such as: cosmic radiation, electrostatic discharge, or software errors. FRU replacement should be considered only when a recurring problem exists.

When analyzing an intermittent problem, do the following:

1. Run the advanced diagnostic test for the system board in loop mode at least 10 times.
2. If no error is detected, do not replace any FRU.
3. If any error is detected, replace the FRU. Rerun the test to verify that there are no more errors.

Undetermined Problems

The diagnostic problems does not identify which adapter or device failed, which installed devices are incorrect, whether a short circuit is suspected, or whether the system is inoperative.

Follow these procedures to isolate the failing FRU (do not isolate non-defective FRU).

NOTE: Verify that all attached devices are supported by the computer.

NOTE: Verify that the power supply being used at the time of the failure is operating correctly.

1. Power-off the computer.
2. Visually check them for damage. If any problems are found, replace the FRU.
3. Remove or disconnect all of the following devices:
 - Non-Acer devices
 - Devices attached to the port replicator
 - Printer, mouse, and other external devices
 - Battery pack
 - Hard disk drive
 - DIMM
 - CD-ROM
 - Diskette drive
 - PC Cards
4. Power-on the computer.
5. Determine if the problem has changed.
6. If the problem does not recur, reconnect the removed devices one at a time until you find the failing FRU.
7. If the problem remains, replace the following FRU one at a time. Do not replace a non-defective FRU:
 - System board
 - LCD assembly

Index of PQA Diagnostic Error Code, Message

Error Code	Message	Action in Sequence
16XXX	Backup battery error	Backup battery
01XXX	CPU or main board error	Reload BIOS default setting. System board
02XXX	Memory error	DIMM System board
03XXX	Keyboard error	Reset Keyboard Keyboard System board
04XXX	Video error	System board
05XXX	Parallel Port error	System board
06XXX	Serial port or main board error	System board
07XXX	Diskette drive error	Diskette drive System board
08XXX	Hard disk error	Reload BIOS default setting Hard disk System board
09XXX	CD-ROM error	Reset CD-ROM cable CD-ROM drive System board
10XXX	Co-processor error	System board
11XXX	Pointing device error	Reset Keyboard Keyboard System board
12XXX	Cache test error	System board

Jumper and Connector Locations

Top View

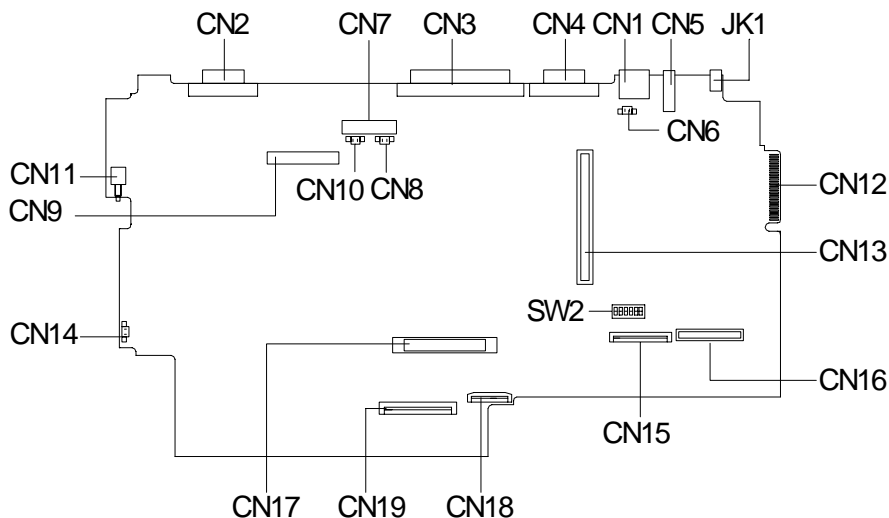

PCB No. 99206

CN1	PS/2 Port	CN12	Golden Finger for Debug
CN2	VGA Port	CN13	PCMCIA Slot
CN3	Parallel Port	CN14	Fan Connector
CN4	Serial Port	CN15	Diskette Drive Connector
CN5	USB Port	CN16	CD-ROM Connector
CN6	LCD Cover Switch Connector	CN17	HDD Connector
CN7	LED Board Connector	CN18	Touch Pad Connector
CN8	RTC Battery Connector	CN19	Internal Keyboard Connector
CN9	LCD Connector	JK1	AC Adapter Connector
CN10	Fan Connector (Reserve)	SW2	Keyboard Type / OEM / Password Switch
CN11	Power Push Switch		

SW2 Settings

	Setting
Switch 1, Switch 2, Switch 6	Off, Off, Off : English Keyboard On, Off, Off : Japanese Keyboard Off, On, Off : European Keyboard Off, Off, On : UK Keyboard
Switch 5	On : Bypass password Off : Check password

Bottom View

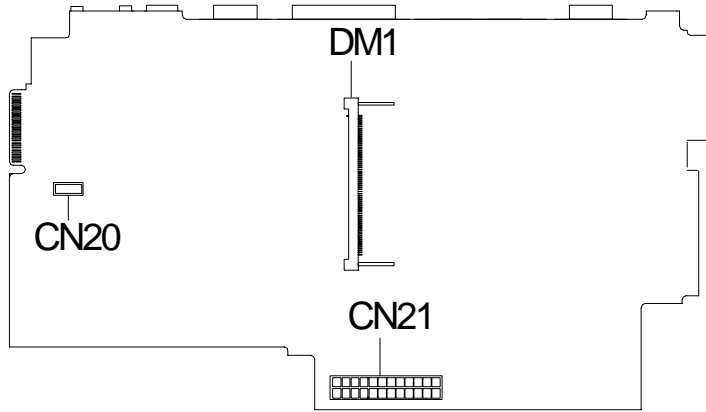

- | | |
|------|---------------------------|
| CN20 | Modem Board Connector |
| CN21 | Audio / Battery Connector |
| DM1 | DIMM Socket |

FRU (Field Replaceable Unit) List

This chapter gives you the FRU (Field Replaceable Unit) listing in global configurations of TravelMate 505P. Refer to this chapter whenever ordering for parts to repair or for RMA (Return Merchandise Authorization).







IMPORTANT: Please note that WHEN ORDERING FRU PARTS, you should check the most up-to-date information available on your regional web or channel. For whatever reasons a part number change is made, it will not be noted in the printed Service Guide. For ACER-AUTHORIZED SERVICE PROVIDERS, your Acer office may have a DIFFERENT part number code to those given in the FRU list of this printed Service Guide. You MUST use the local FRU list provided by your regional Acer office to order FRU parts for repair and service of customer machines.

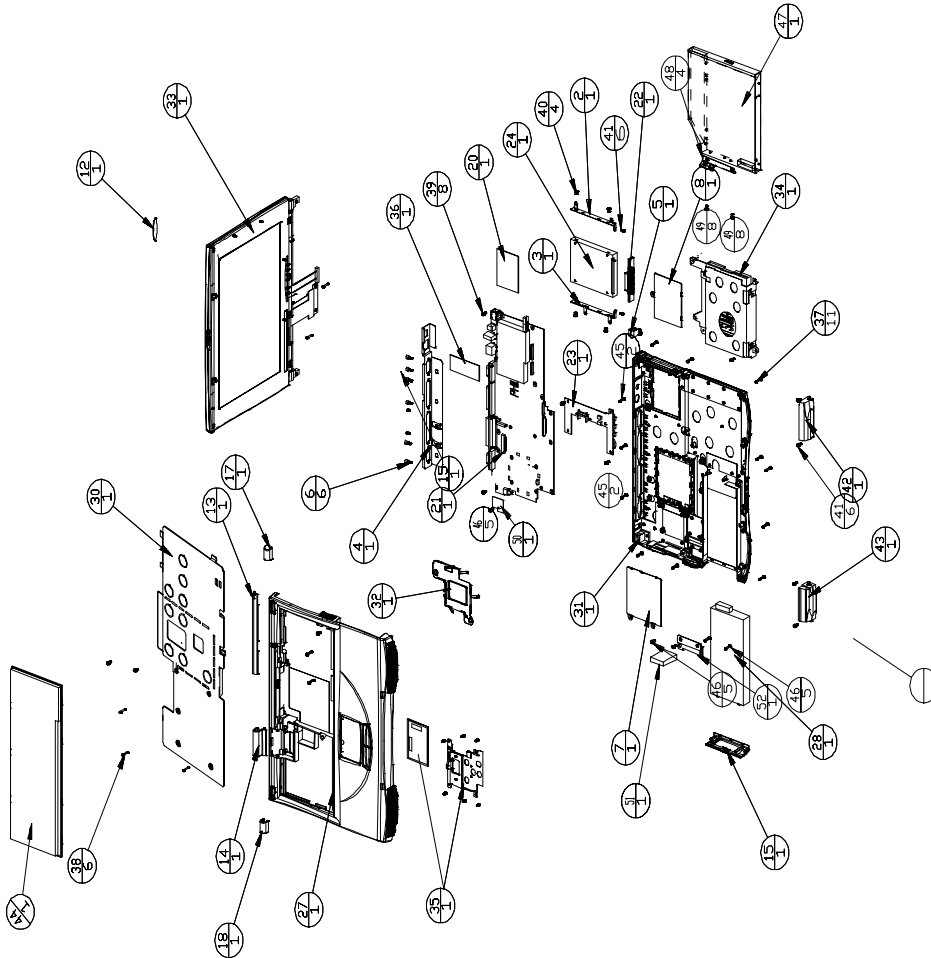





NOTE: To scrap or to return the defective parts, you should follow the local government ordinance or regulations on how best to dispose it, or follow the rules set by your regional Acer office on how to return it.







NOTE: The number indicates the location shown on exploded diagram or "NS" indicates "Not shown" on it







NO.	PART NO.	DESCRIPTION	QTY
2	33-45B01.003	BRK HDD (R) SECC AN500	1
3	33-45B02.004	BRK HDD SECC AN500	1
4	33-45F02.001	BKT I/O AL FALCON	1
5	33-45B09.001	BRK RJ11 SECC AN500	1
6	34-00015.011	SCW HEX NYL W/WASHER#4-	6
7	34-45B03.001	CVR DIMM AL 050 AN500	1
8	34-45B04.001	COVER MDEM AL AN500	1
12	40-43A02.001	LOGO PLATE	1
13	42-45B01.001	MIDDLE COVERD	1
14	42-45B02.002	MIDDLE COVERG	1
15	42-45B04.001	DOOR BATTERY PC AN500	1
17	42-47A14.001	CAP HINGERS PC	1
18	42-47A15.001	CAP HINGE CL PC	1
20	34-09012.041	MOEM SK ID/07/00	1
21	55-43F01.001	FALCON WIN DRWG C40	1
22	55-43F02.001	FALCON HDD TRANSPORT BD	1
23	55-43F03.001	FALCON AUDIO BOARD	1
24	56-02A07.031	HDD IBM/4.85 DARA64000	1
25	56-1743F.001	TOUCHPAD	1
27	60-43P02.001	UPPER CASE ASSY	1
28	60-45B04.011	BATTERY	1
30	34-45C15.002	UP HSINK PC-AL FALCON	1
31	60-43P03.001	ASSY L CASE FALCON	1
32	33-45C08.001	CPU EMI BRK	1
33	65-43F01.011	ASSY LCD MODULE(HIGH12.1ITF)	1
34	65-43F02.001	ASSY CD-ROM FDD FALCON	1
35	65-43F03.001	ASSY T-F/CD-ROM CNTRL BD 65	1
36	72-25349.00N	SU-DPMH	1
37	86-1A353.132	SCREW MACH PAN M2.5X13.5L NY	13
38	86-1A322.140	SCREW MACH PAN NEM14L	5
39	86-1A523.6R0	SCREW MACH PAN M2.9X6L NY	8
40	86-1A524.4R0	SCREW MACH FL N3M4L NI	4
41	86-1A522.4R0	SCREW MACH PAN M2X4L	4
42	90-43P12.002	SPEAKER BOX R	1
43	90-43P12.001	SPEAKER BOX L	1
44	91-78S07.001	KEYBOARD NSK-8A401	1
46	86-1A523.4R0	SCREW MACH PAN M2.9X4L NY	4
47	56-10061.141	CIRCU TEAL/CD-324E-A06 24X	1
48	33-45C05.001	BRK CDROM-3 SLUS	1
49	86-1A522.3R0	SCREW MACH PAN M2.9X4L NY	2
51	23-10033.071	FAN 30X30X10.3MM	1
52	34-45C06.001	FAN BRK SECC 510	1
53	40-45C07.001	MYLAR CD/DVD	1
54	47-45B06.001	SPONGE TP FPC 500	1
55	50-43P03.001	C.A. RJ-11 FALCON	1



Picture	No.	Partname	Description	Part No.
LCD				
	33	LCD Module 12.1" DSTN Sharp	ASSY LCD 12.1" DSTN SHARP TM505	6M.43F01.001
	NS	12.1" SVGA DSTN LCD, Sharp	LCD 12.1" DSTN LM121SS1T53 BLACK	56.0743B.001
	NS	LCD Bezel	ASSY LCD BZL 12.1" FALCON	60.43F01.001
	NS	LCD Panel DSTN	ASSY PNL 12.1" SHARP FALCON	60.43F07.001
	NS	12.1" Inverter, Ambit	INVERTER T62.121.C.00.510	19.21030.461
	NS	LED Board	EXTENSA 700 LED BOARD	55.47A03.001
	NS	LCD FPC DSTN Cable	C.A FPC 12.1" DSTN SHARP 510	50.45C07.001

Picture	No.	Partname	Description	Part No.
	NS	LED Cable	W.A 10/10P 120MM LED AN500	50.45B11.001
	33	LCD Module 12.1" TFT Hitachi	ASSY LCD 12.1" TFT HITACHI TM505	6M.43F01.011
	NS	12.1" SVGA TFT LCD, Hitachi	LCD 12.1" TFT HIT/ TX31D27VCICBB	56.0746B.011
	NS	LCD Bezel	ASSY LCD BZL 12.1" FALCON	60.43F01.001
	NS	LCD Panel TFT	ASSY PNL 12.1" HITACHI FALCON	60.43F07.011
	NS	12.1" Inverter, Ambit	INVERTER T62.121.C.00.510	19.21030.461
	NS	LED Board	EXTENSA 700 LED BOARD	55.47A03.001





Picture	No.	Partname	Description	Part No.
	NS	LCD FPC TFT	C.A FPC LCD 12.1" TFT HIT 510	50.45C06.001
	NS	LED Cable	W.A 10/10P 120MM LED AN500	50.45B11.001
	33	LCD Module 12.1" TFT IBM/ OEM	ASSY LCD 12.1" IBM TM505	6M.43F01.021
	NS	12.1" SVGA TFT LCD, IBM/ OEM	LCD 12.1" TFT IBM/ OEM53C1-01	56.0750A.001
	NS	LCD Bezel	ASSY LCD BZL 12.1" FALCON	60.43F01.001
	NS	LCD Panel TFT	ASSY LCD PNL 12.1" IBM FALCON	60.43F06.001
	NS	12.1" Inverter, Ambit	INVERTER T62.121.C.00.510	19.21030.461







Picture	No.	Partname	Description	Part No.
	NS	LED Board	EXTENSA 700 LED BOARD	55.47A03.001
	NS	LCD FPC TFT Cable	C.A FPC 12.1" TFT HIT FALCON	50.43F04.001
	NS	LED Cable	W.A 10/10P 120MM LED AN500	50.45B11.001
HDD				
	NS	HDD Module	ASSY HDD 4.8GB	6M.43F03.001
	24	4.8GB HDD, IBM	HDD IBM/4.8 DARA204000	56.02A07.031
	NS	HDD Module	ASSY HDD 6GB	6M.43F03.011
	24	6.0GB HDD, IBM	HDD SM 9.5" 6G IBM/ DARA-206000	56.02A02.041





Picture	No.	Partname	Description	Part No.
	3	HDD Bracket	BRK HDD SECC AN500	33.45B02.004
	2	HDD Bracket	BRK HDD(R) SECC AN500	33.45B02.003
	22	HDD Connection Board	FALCON HDD TRANSPORT BD	55.43F02.001
CD-ROM & FDD				
	34	CD-ROM & FDD Module	CD-ROM & FDD MODULE EXT5	6M.45C01.001
	47	24X CD-ROM	CD-ROM TEAH/CD-224E-A26 24X	56.10061.141
	NS	3.5" FDD, Mitsumi	FDD W/500 BZL MITS/D353F3X	56.01051.371
	NS	FDD Cable	C.A FPC FDD FALCON	50.43F02.001





Picture	No.	Partname	Description	Part No.
	NS	CD-ROM Cable	C.A FPC CD-ROM AN510	50.45C02.001
Modem				
	20	56K SW Modem, Ambit	MODEM 56K AMBIT/T62M145.00	54.09011.241
	20	56K SW Modem, Aopen	MODEM MDC S/W NET	54.09025.001
Speaker				
	42 43	Speaker	SPEAKER PACK TM505	6K.43F02.001
Touchpad				
	NS	Touchpad Module	ASSY TOUCHPAD FALCON	6M.43F02.001
	NS	Touchpad Bracket	ASSY TP HLD FALCON	60.43F04.001
	25	Touchpad, Synaptics	TOUCHPAD SYNAPTIC ATP TM41P-30	56.1743F.001
	NS	Touchpad Cable	C.A FPC TP FALCON	50.43F01.001

Picture	No.	Partname	Description	Part No.
Power				
	NS	AC Adapter, Delta	ADT 90-270V ADP-60JB V.A 720	25.10064.031
	28	NiMH Battery, Panasonic	ASSY BTY PACK 99-R0500-001 500	60.45B04.011
	NS	Power cord U.S	CORD SPT-2 # 18*2C 7A125V1830MM	27.01618.001
PCB				
	21	Celeron-400 Main Board	FALCON MB(SMD) C-400	55.43F01.001
	22	HDD Connection Board	FALCON HDD BOARD	55.43F02.001
	23	Audio I/O Battery Connection Board	FALCON AUDIO BOARD	55.43F03.001
	NS	LED Board	EXTENSA 700 LED BOARD	55.47A03.001

Picture	No.	Partname	Description	Part No.
Memory				
	NS	DIMM 32MB, SDRAM, Mitsubishi	SDIMM 32M MH4S64BBKG-8 PC100(MI)	72.00464.00N
	NS	DIMM 32MB, SDRAM, Siemens	SDIMM 32M HYS64V4200GDL-8(SIE)	72.64420.A0N
	36	DIMM 32MB, SDRAM, Mosel	SO-DIMM 32M V43644Y04VTG-10PC	72.43644.00N
	NS	DIMM 64MB, SDRAM, NEC	SDIMM 64M 4564163G5-A10B-9JFB	72.25359.B0N
	NS	DIMM 64MB, SDRAM, Mitsubishi	SDIMM 64M MH8S64BBKG-8 PC100	72.00864.00N
	NS	DIMM 64MB, SDRAM, Siemens	SDRAM 64M HYS64V8300GU-8(SIE-I)	72.64820.B0N
	36	DIMM 64MB, SDRAM, Mosel	SO-DIMM 64M V43648Z04VTG-10PC	72.43648.00N
	NS	DIMM 128MB, SDRAM, Samsung	SDIMM 128M KMM464S1723T2-GL	72.46172.A0N
	36	DIMM 128MB, SDRAM, Siemens	SODIMM 128M HYS64V16220GC DL-8	72.64162.C0N
	NS	DIMM 128MB, SDRAM, Mitsubishi	SDIMM 128M MH16S64KD-8 PC100	72.00664.00N
Cable				
	55	RJ-11 Cable	CABLE RJ-11 FALCON	50.43F03.001
	NS	Touchpad FPC	C.A FPC TP FALCON	50.43F01.001
Mechanical Parts				
	5	RJ-11 Shield	BKT RJII SECC AN500	33.45B09.001

Picture	No.	Partname	Description	Part No.
	27	Upper case module	ASSY UP CASE FALCON	60.43F02.001
	31	Lower case module	ASSY LOW CASE FALCON	60.43F03.001
	15	Battery door	DOOR BATTERY PC AN500	42.45B04.001
	7	DIMM cover	CVR DIMM AL 050 AN500	34.45B03.002
	8	Modem cover	CVR MODEM AL AN500	34.45B04.002
	13	Middle cover(Long)	CVR MIDDLE (1) PC 050 AN500	42.45B01.001
	14	Middle cover(Short)	CVR MIDDLE(2)	42.45B02.002

Picture	No.	Partname	Description	Part No.
	17 18	Hinge Cover Pack	ASSY HINGE COVER PACK TM505	6M.45B08.001
	32	CPU EMI Shield	BRKT CPU EMI CU AN510	33.45C08.001
	30	Upper Heat Sink	HSINK UP C/PII 300/ 333/366 510	34.45C15.001
	52	Fan Bracket	BRKT FAN SECC AN510	33.45C06.001
	NS	Cover Switch Cable/ Wire	W.A CVR SW/2P 45MM AN700	50.47A10.001
	NS	Hinge Pack	Hinge Pack TM505	6K.43F01.001

Picture	No.	Partname	Description	Part No.
Others				
	NS	RTC Battery	BTY LI 3V ML2032T6 65MAH	23.20004.101
	51	Fan	FAN 30*30*10 AD0305LB-G73	23.10033.071
	41	Screw	SCREW MACH PAN M2X4L	86.9A522.4R0
	46	Screw	SCREW MACH PAN M2.5*4L NY	86.1A523.4R0
	39	Screw	SCRW MACH PAN M2.5*6L NI	86.1A523.6R0
	37	Screw	SCREW MACH PAN M2.5X13.5L NY	86.1A353.135
	38	Screw	SCREW MACH PAN M2X14L	86.1A522.140
	40	Screw	SCREW MACH FL M3*4L NI	86.5A524.4R0
	49	Screw	SCRW MACH VAFER R2X4L	86.9A522.3R0
Miscellaneous Parts				
	NS	Base Grip	FOOT PU BLACK 350P	47.45001.001
	NS	LCD Latch	LATCH LCD 700	42.47A01.002
	NS	LCD Latch Spring	SPRING EJ-KNOB SWP 300	34.47604.001
	NS	FDD Mylar	MYLAR 2 FDD AN500	40.45B16.002
	NS	CD-FDD Insulator Mylar	MYLAR INSULATOR SHT CD FDD VEGA	40.45B40.002
	53	CD-ROM Mylar	MYLAR-1 CD-ROM AN500	40.45B09.001
	NS	Rubber LCD Cushion	RUBBER LCD CUSHION SILICON 050	47.46930.011
	NS	Hinge Screw Mylar	MYLAR FOR HINGE PC390	40.43A01.081
	NS	LCD Screw Cap	CSN SCREW SILICON 050 6*3H 800	47.49A02.001

Picture	No.	Partname	Description	Part No.
Keyboard				
	44	API Keyboard	NSK-84A6C	91.78S07.06C
	NS	API Keyboard	SWISS/FRE/GER (85)	91.78S07.070
	NS	API Keyboard	US (84)	91.78S07.071
	NS	API Keyboard	US INTERNATIONAL(84)	91.78S07.072
	NS	API Keyboard	THAI (84)	91.78S07.073
	NS	API Keyboard	ARABIC/US (84)	91.78S07.074
	NS	API Keyboard	SOUTH AFRICA(84)	91.78S07.075
	NS	API Keyboard	CZECH(84)	91.78S07.079
	NS	API Keyboard	ARABIC/SAKHA (84)	91.78S07.07A
	NS	API Keyboard	BELGIUM (85)	91.78S07.07B
	NS	API Keyboard	CHINESE (84)	91.78S07.07C
	NS	API Keyboard	DENMARK (85)	91.78S07.07D
	NS	API Keyboard	ITALIAN (85)	91.78S07.07E
	NS	API Keyboard	FRENCH (85)	91.78S07.07F
	NS	API Keyboard	GERMAN (85)	91.78S07.07G
	NS	API Keyboard	HEBREW (84)	91.78S07.07H
	NS	API Keyboard	KOREAN (84)	91.78S07.07K
	NS	API Keyboard	SLOVAKIA(84)	91.78S07.07L
	NS	API Keyboard	NORWEGIAN (85)	91.78S07.07N
	NS	API Keyboard	HOLLAND(85)	91.78S07.07O
	NS	API Keyboard	PORTUGA (85)	91.78S07.07P
	NS	API Keyboard	HUNGARIAN(85)	91.78S07.07Q
	NS	API Keyboard	RUSSIAN (84)	91.78S07.07R
	NS	API Keyboard	SPANISH (85)	91.78S07.07S
NS	API Keyboard	TURKEY (85)	91.78S07.07T	
NS	API Keyboard	UK (85)	91.78S07.07U	
NS	API Keyboard	SWEDEN (85)	91.78S07.07W	

Model Definition and Configuration

Model Number Definitions

Model Number	LCD	CPU	Memory	HDD	CD	Battery
505DX	12.1" HPA	Mobile -Celeron-400 MHz Processor	32MB	4.8GB	24x	NiMH
505T	12.1" TFT	Mobile -Celeron-400 MHz Processor	32MB	4.8GB	24x	NiMH
506DX	12.1" HPA	Mobile -Celeron-433 MHz Processor	32 or 64MB	4.8GB	24x	NiMH
506T	12.1" TFT	Mobile -Celeron-433 MHz Processor	32 or 64MB	4.8GB	24x	NiMH

Test Compatible Components

This computer's compatibility is tested and verified by Acer's internal testing department. All of its system functions are tested under Windows 98 environment.

Refer to the following lists for components, adapter cards, and peripherals which have passed these tests. Regarding configuration, combination and test procedures, please refer to the TravelMate 505 Compatibility Test Report released by the Acer Mobile System Testing Department.

Microsoft Windows 98 ACPI Environment Test

Items	Specifications
Processor	Intel Celeron 366/433/466
Hard Disk Drive	IBM 9.5mm 6.0 GB IBM 9.5mm 9.0 GB
Floppy Disk Drive	Mitsumi D353F3
CD-ROM Drive	TEAC CD-224E-A26 24X
Memory	32 MB 64 MB
Power	Panasonic Ni-MH battery 8cell Delta 60W
LCD	Hitachi 12.1" SVGA TFT IBM 12.1" SVGA TFT Sharp 12.1" SVGA DSTN
I/O Adapter	
Display	IBM G42 9514-B04 TFT monitor AcerView 76i AcerView 98i Color monitor V70 20" color monitor Flex Scan E35F
PCMCIA - SCSI	Adaptec SlimSCSI APA-1460AB NewMedia BUS Toaster PCMCIA to SCSI
PCMCIA - CDROM	IBM Portable 20x Speed CD-ROM Drive w/ SOUND (JP) Panasonic 4x Portable CD-ROM Sound Player Panasonic 20x Portable CD-ROM Player
PCMCIA - ATA	SunDisk ATA 15MB EPSON Flash Packer 6MB
Network Adapter	
LAN Ethernet/10baseT/100baseT	3Com Etherlink III 3Com 10/100 16bits Fast EtherLink Intel EtherExpress PRO/100 Mobile Adapter Xircom CreditCard Ethernet adap. Xircom CreditCard Ethernet Adapter IIps Xircom CreditCard Ethernet Adapter 10/100 IBM EtherJet PC Card
LAN Token Ring	IBM TokenRing 16/4 AdapterII IBM Turbo 16/4 TokenRing PC card
Multi-Function Card	3Com 10/100 Fast EtherLink Lan + 56K Dlink Winconnect 33.6 Lan/Fax modem Combo Megahertz PC Card 33.6 Ethernet-Modem with XJACK Xircom CreditCard Ethernet 10/100 + Modem 56 Xircom RealPort Ethernet 10/100 + Modem 56
CardBus	3Com Fast EtherLink XL cardbus Intel EtherExpress PRO/100 Mobile Adapter TDK CardBus Ethernet 10/100 Base TX D-Link Fast Ethernet CardBus 10/100 mbps IBM 10/100 EtherJet CardBus Adapter (32-bit)

Items	Specifications
Modem Adapter	
Modem (up to 28.8K)	Xircom PCMCIA Fax/Modem 28.8m
Modem (up to 33.6K)	Dlink Winconnect 33.6 Fax modem IBM PCMCIA Data/Fax Modem International 33.6/14.4
Modem (up to 56K)	Megahertz Datalink 56k fax/modem ActionTec Datalink 56Kbps Fax/Modem TDK K56K Modem V.90/K56flex USR Megahertz 56K modem IBM 56K Double Jack Modem
ISDN	IBM ISDN Internet PC card

Online Support Information

This appendix describes online technical support services available to help you repair your Acer systems.

If you are a distributor, dealer, ASP or TPM, please refer your technical queries to your local Acer branch office. Acer Branch Offices, Regional Offices and Regional Groups may access our website. However, some information sources will require a user I.D. and password. These can be obtained directly from Acer CSD Taiwan.

Acer's website offers you convenient and valuable support resources whenever you need them.

You can find information on all of Acer's Notebook, Desktop and Server models including:

- Service guides for all models
- User's manuals
- Training materials
- BIOS updates
- Software utilities

Also contained on this website is

- Detailed information on Acer's International Traveler's Warranty (ITW)
- An overview of all the support services we offer, accompanied by a list of telephone, fax and e-mail contacts for all of your technical queries.

Here is the Acer headquarters' Customer Service Division Internet address for your support information:

<http://csd.acer.com.tw>

If you have any suggestions or comments, please do not hesitate to communicate these to TerryMasi@acer.com.tw, or fax to (886) 2 86911799.

A

AC Adapter 23
 AFlash Utility 36
 ASP 93
 Asset Tag Number 28
 Audio Interface 18

B

Basic System Configuration 30
 Battery 21
 battery pack
 charging indicator 14
 BIOS 15
 BIOS Setup Utility 27
 BIOS Utility 27–35
 Basic System Settings menu 30
 entering 27
 Load Default Settings menu 35
 navigating 27
 Onboard Devices Configuration menu 32
 Startup Configuration menu 31
 System Security menu 33
 Block Diagram 8
 Board Layout 9
 Bottom View 10
 Top View 9
 brightness
 hot keys 5

C

caps lock 3
 on indicator 14
 CD-ROM Drive 90
 CD-ROM Interface 17
 computer
 on indicator 14
 Connector Types 42
 contrast
 hot keys 5
 CPU 28

D

date

 setting in BIOS Utility 30
 DC-AC LCD Inverter 22
 DC-DC/Charger Converter 21
 Disassembly Procedure Flowchart 43
 Display 2
 display
 hot keys 5
 setting boot device in BIOS Utility 31
 DMA Channel Assignment 26

E

Environmental Requirements 24
 Euro Symbol 4
 External CD-ROM Drive Check 58

F

Features 1
 Keyboard Ergonomics 6
 Expansion 1
 Keyboard 3
 Touchpad 6
 Floppy Disk Drive 90
 Floppy Disk Drive Interface 17
 FRU 73
 Cable 82
 CD-ROM 79
 FDD 79
 HDD 78
 Keyboard 86
 LCD 75
 Mechanical Parts 82
 Memory 82
 Miscellaneous Parts 85
 Modem 80
 PCB 81
 Power 81
 Speaker 80
 Touchpad 80

H

Hard Disk Drive 90
 Hard Disk Drive Interface 17
 Hardware Specifications and Configurations 15
 Hibernation mode
 hot key 5

I

I/O Adapter 90
I/O Address Map 25
Index of Error Message 61
 No-Beep Symptoms 63
Index of Symptom-to-FRU Error Message 64
 Indicator 64
 Keyboard 66
 LCD 64
 Memory 65
 Modem 67
 PCMCIA 65
 Peripheral 66
 Power 64
 Power Management 65
 Speaker 65
 Touchpad 66
Indicators 14
Intermittent Problems 68
IrDA Port 20
IRQ Assignment Map 26

J

Jumper and Connector Locations
 Bottom View 72
 SW2 Settings 71
 Top View 71

K

Keyboard 20
 Hot Keys 5
 Special Keys 3
Keyboard or Auxiliary Input Device Check 58

L

LAN Interface 16
LCD 22, 90
Load Default Settings 35

M

Machine Disassembly and Replacement 41
 Battery Pack 45
 CD-ROM Drive 56
 DIMM 45
 Floppy Disk Drive 56
 General Information 42
 Hard Disk Drive Module 55
 Keyboard 46
 LCD 48
 LCD Module 47
 Main Unit 50
 Audio I/O Board 53
 Battery Connection Board 53
 CD-ROM Drive 51

CPU EMI Shield 50
Fan 53
Floppy Disk Drive 51
Hard Disk Drive 50
Heatsink 50
Mainboard 53
PCMCIA Card 54
Speakers 52
Touchpad Module 54
Upper Case 51
Modem Board 45
Mainboard Data Utility 37
Mechanical Specifications 24
media access
 on indicator 14
Memory 90
Memory Address Map 25
Memory Check 59
Memory Combinations 16
Microsoft Windows 98 ACPI Environment Test 90
Model Number Definitions 87
Modem Adapter 91
MODEM Interface 16

N

Network Adapter 90
Notebook Manager
 hot key 5
num lock 3
 on indicator 14

O

Onboard Device Configuration 32

P

Panel
 Front 11
 Rear 12
 Right 13
Panel ID Utility 37
Panels 11
Parallel Port 19
parallel port
 setting in BIOS Utility 32
password
 changing in BIOS Utility 34
 removing in BIOS Utility 34
 setting in BIOS Utility 33
Password icons 34
PCMCIA Port 20
Power 90

- Power Management 2, 24
- Power System Check 59
 - Battery Pack 60
 - Power Adapter 59
- Processor 15, 90

S

- Scroll Lock 3
- Second-Level Cache 15
- Serial Number 28
- Serial Port 19
- serial port
- setting in BIOS Utility 32
- speakers
 - hot key 5
- Standby mode
 - hot key 5
 - status indicator 14
- Startup Configuration 31
- System Board Major Chips 15
- System Check Procedures 58
- System Diagnostic Diskette 38
- System Information 28
- System Memory 16
- System Security 33
- System Utility Diskette 37

T

- Thermal and Fan Utility 37
- time
 - setting in BIOS Utility 30
- touchpad
 - hot key 5
- Touchpad Check 60
- TPM 93
- Troubleshooting 57

U

- Undetermined Problems 69
- USB 12
- USB Port 20
- utility
 - BIOS Setup 27–35
- UUID 29

V

- Video Interface 18
- Video Memory 18
- Video Resolution Modes 19

W

- Windows Keys 4

